

KENWOOD

INSTRUCTION MANUAL



HF/ 50 MHz ALL MODE TRANSCEIVER

TS-480HX

TS-480SAT

KENWOOD CORPORATION

© B62-1735-10 (K, E)
09 08 07 06 05 04 03 02 01 00

NOTICE TO THE USER

One or more of the following statements may be applicable for this equipment.

FCC WARNING

This equipment generates or uses radio frequency energy. Changes or modifications to this equipment may cause harmful interference unless the modifications are expressly approved in the instruction manual. The user could lose the authority to operate this equipment if an unauthorized change or modification is made.

INFORMATION TO THE DIGITAL DEVICE USER REQUIRED BY THE FCC

This equipment has been tested and found to comply with the limits for a Class B digital device, pursuant to Part 15 of the FCC Rules. These limits are designed to provide reasonable protection against harmful interference in a residential installation.

This equipment generates, uses and can generate radio frequency energy and, if not installed and used in accordance with the instructions, may cause harmful interference to radio communications. However, there is no guarantee that the interference will not occur in a particular installation. If this equipment does cause harmful interference to radio or television reception, which can be determined by turning the equipment off and on, the user is encouraged to try to correct the interference by one or more of the following measures:

- *Reorient or relocate the receiving antenna.*
- *Increase the separation between the equipment and receiver.*
- *Connect the equipment to an outlet on a circuit different from that to which the receiver is connected.*
- *Consult the dealer for technical assistance.*

BEFORE STARTING

Amateur radio regulations vary from country to country. Confirm your local amateur radio regulations and requirements before operating the transceiver.

Depending on the size and type of vehicle, the maximum transmission output power for the mobile operation will vary. The maximum transmission output power is usually specified by the car manufacturer to avoid interference with other electric devices used in the vehicle. Consult your car manufacturer and amateur radio equipment dealer for the requirements and installation.

THANK YOU

Thank you for choosing this **KENWOOD** TS-480HX/ SAT transceiver. It has been developed by a team of engineers determined to continue the tradition of excellence and innovation in **KENWOOD** transceivers.

This transceiver features a Digital Signal Processing (DSP) unit to process AF signals. By taking maximum advantage of DSP technology, the TS-480HX/ SAT transceiver gives you enhanced interference reduction capabilities and improves the quality of audio. You will notice the differences when you fight QRM and QRN. As you learn how to use this transceiver, you will also find that **KENWOOD** is pursuing "user friendliness". For example, each time you change the Menu No. in Menu mode, you will see scrolling messages on the display that tell you what you are selecting.

Though user friendly, this transceiver is technically sophisticated and some features may be new to you. Consider this manual to be a personal tutorial from the designers. Allow the manual to guide you through the learning process now, then act as a reference in the coming years.

FEATURES

- All mode operation from HF to 50 MHz amateur radio band
- Separate Remote Control panel for mobile operation
- Digital Signal Processing (DSP) unit
- Adjustable DSP filter frequencies
- A built-in Antenna Tuner for the HF/ 50 MHz band (TS-480SAT)
- 200 watts output power (SSB, CW, FSK, FM) and 50 watts output power (AM) for the TS-480HX.

SUPPLIED ACCESSORIES

After carefully unpacking the transceiver, identify the items listed in the table below. We recommend you keep the box and packing materials in case you need to repack the transceiver in the future.

Accessory	Part Number	Quantity				
		TS-480SAT		TS-480HX		
		K	E	K	E	
Microphone	T91-0638-XX	1	1	1	1	
DC power cable	E30-3489-XX	1	1	2	2	
mini DIN plug (6-pin male)	E57-0404-XX	1	1	1	1	
mini DIN plug (8-pin male)	E57-0405-XX	1	1	1	1	
Modular cable (RJ-11 4 m)	E30-3488-XX	1	1	1	1	
Modular cable (RJ-11 20 cm)	E30-3500-XX	–	1	–	1	
Fuse (25 A)	F05-2531-XX	1	1	2	2	
Fuse (4 A)	F06-4027-XX	1	1	1	1	
Screw Set for brackets (A)	N99-2035-XX	1	1	1	1	
L-bracket	J29-0706-XX	2	2	2	2	
Panel holder	J29-0663-XX	1	2	1	2	
Panel bracket (mobile)	J29-0707-XX	1	1	1	1	
Panel bracket (base)	J09-0409-XX	1	1	1	1	
Line filter with a retaining band	L79-1408-XX	–	1	–	2	
Line filter for Panel	L79-1417-XX	1	1	1	1	
Portable bracket	J29-0705-XX	–	1	–	1	
Carrying handle	K01-0420-XX	–	1	–	1	
Screw set for Portable bracket (B)	N99-2041-XX	–	1	–	1	
Instruction Manual	B62-1735-XX	E	1	1	1	1
	B62-1750-XX	F	–	1	–	1
	B62-1752-XX	S	–	1	–	1
	B62-1736-XX	G	–	1	–	1
	B62-1751-XX	I	–	1	–	1
	B62-1753-XX	D	–	1	–	1
Schematic/ Block Diagrams	B52-0619-XX	1	–	1	–	
	B52-0620-XX	–	–	–	–	
Warranty card	–	1	1	1	1	

THANK YOU

MODELS COVERED BY THIS MANUAL

The models listed below are covered by this manual.

TS-480HX : HF/ 50 MHz All mode Transceiver
(200 watts output: SSB, CW, FSK,
FM/ 50 watts output: AM)

TS-480SAT: HF/ 50 MHz All mode Transceiver with
Automatic Antenna Tuner (100 watts
output: SSB, CW, FSK, FM/
25 watts: AM)

MARKET CODES

K-type : The Americas

E-type : Europe/ General

The market code is shown on the carton box.

Refer to the specifications {page 91} for information
on the available operating frequencies.

WRITING CONVENTIONS FOLLOWED

The writing conventions described below have been
followed to simplify instructions and avoid
unnecessary repetition.

Instruction	What to Do
Press [KEY] .	Press and release KEY .
Press [KEY1], [KEY2] .	Press KEY1 momentarily, release KEY1 , then press KEY2 .
Press [KEY] (1 s) .	Press and hold KEY down for a second and then release KEY .
Press [KEY1]+[KEY2] .	Press and hold KEY1 down, then press KEY2 . If there are more than two keys, press and hold down each key in turn until the final key has been pressed.
Press [KEY]+[⏻] .	With the transceiver OFF, press and hold KEY , then switch ON the transceiver power by pressing [⏻] (POWER).

PRECAUTIONS

Please observe the following precautions to prevent fire, personal injury, and transceiver damage:

- Connect the transceiver only to a power source described in this manual or as marked on the transceiver itself.
- Route all power cables safely. Ensure the power cables can neither be stepped upon nor pinched by items placed near or against the cables. Pay particular attention to locations near AC receptacles, AC outlet strips, and points of entry to the transceiver.
- Take care not to drop objects or spill liquid into the transceiver through enclosure openings. Metal objects, such as hairpins or needles, inserted into the transceiver may contact voltages resulting in serious electrical shocks. Never permit children to insert any objects into the transceiver.
- Do not attempt to defeat methods used for grounding and electrical polarization in the transceiver, particularly involving the power input cable.
- Adequately ground all outdoor antennas for this transceiver using approved methods. Grounding helps protect against voltage surges caused by lightning. It also reduces the chance of a build-up of static charge.

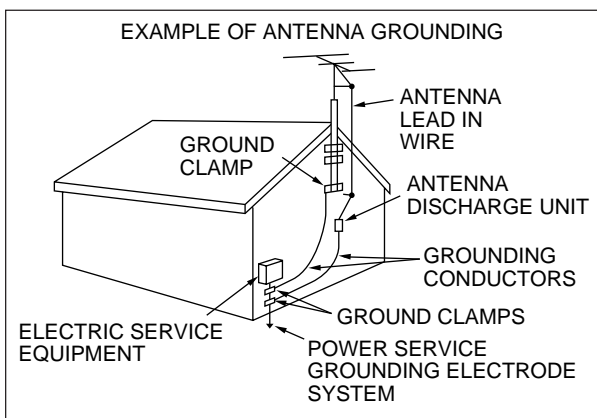

- Minimum recommended distance for an outdoor antenna from power lines is one and one-half times the vertical height of the associated antenna support structure. This distance allows adequate clearance from the power lines if the support structure fails for any reason.
- Locate the transceiver so as not to interfere with its ventilation. Do not place books or other equipment on the transceiver that may impede the free movement of air. Allow a minimum of 10 cm (4 inches) between the rear of the transceiver and the wall or operating desk shelf.
- Do not use the transceiver near water or sources of moisture. For example, avoid use near a bathtub, sink, swimming pool, or in a damp basement or attic.
- The presence of an unusual odor or smoke is often a sign of trouble. Immediately turn the power OFF and remove the power cable. Contact a **KENWOOD** service station or your dealer for advice.

- Locate the transceiver away from heat sources such as a radiator, stove, amplifier or other devices that produce substantial amounts of heat.
- Do not use volatile solvents such as alcohol, paint thinner, gasoline or benzene to clean the cabinet of the transceiver. Use a clean cloth with warm water or a mild detergent.
- Disconnect the input power cable from the power source when the transceiver is not used for long periods of time.
- Remove the transceiver's enclosure only to do accessory installations described in this manual or accessory manuals. Follow provided instructions carefully, to avoid electrical shocks. If unfamiliar with this type of work, seek assistance from an experienced individual, or have a professional technician do the task.
- Enlist the services of qualified personnel in the following cases:
 - a) The power supply or plug is damaged.
 - b) Objects have fallen or liquid has spilled into the transceiver.
 - c) The transceiver has been exposed to rain.
 - d) The transceiver is operating abnormally or performance has seriously degraded.
 - e) The transceiver has been dropped or the enclosure damaged.
- Do not attempt to perform any kind of configuration or menu setup configuration while driving your car.
- Do not wear headphones while driving.
- Install the transceiver in a safe and convenient position inside of your vehicle so as not to subject yourself to danger while driving. Consult your car dealer for the transceiver installation to ensure safety.
- HF/ 50 MHz mobile antennas are larger and heavier than VHF/ UHF antennas. Therefore, use a strong and rigid mount to safety and securely install the HF/ 50 MHz mobile antenna.

CONTENTS

NOTICE TO USER BEFORE STARTING	
THANK YOU	i
FEATURES	i
SUPPLIED ACCESSORIES	i
MODELS COVERED BY THIS MANUAL	ii
MARKET CODES	ii
WRITING CONVENTIONS FOLLOWED	ii
PRECAUTIONS	iii
CONTENTS	iv

CHAPTER 1 INSTALLATION

MOBILE INSTALLATION	1
INSTALLATION EXAMPLE	1
REMOTE CONTROL PANEL INSTALLATION	1
DC POWER CABLE CONNECTION	2
ANTENNA CONNECTION	2
IGNITION NOISE	2
FIXED STATION INSTALLATION	3
REMOTE CONTROL PANEL INSTALLATION	3
DC POWER SUPPLY CONNECTION	3
ANTENNA CONNECTION	4
GROUND CONNECTION	4
LIGHTNING PROTECTION	4
PORTABLE BRACKET (E-TYPE ONLY)	5
FUSES	5
PANEL AND MICROPHONE CONNECTION	6
PANEL AND MICROPHONE CONNECTION USING PG-4Z (OPTION)	6
ACCESSORY CONNECTIONS	
TX/RX UNIT	
Microphone (MIC)	7
External Speaker (EXT.SP)	7
Keys for CW (PADDLE and KEY)	7
REMOTE CONTROL PANEL	
Headphones (PHONES)	7

CHAPTER 2 YOUR FIRST QSO

RECEPTION	8
TRANSMISSION	9

CHAPTER 3 GETTING ACQUAINTED

REMOTE CONTROL PANEL	10
LCD DISPLAY	13
TX/RX UNIT	15
REMOTE CONTROL PANEL (REAR)	17
MICROPHONE	17

CHAPTER 4 OPERATING BASICS

SWITCHING POWER ON/OFF	18
ADJUSTING VOLUME	18
AF (AUDIO FREQUENCY) GAIN	18
RF (RADIO FREQUENCY) GAIN	18
SELECTING VFO A OR VFO B	18
SELECTING A BAND	19
SELECTING A MODE	19
ADJUSTING SQUELCH	19
SELECTING A FREQUENCY	19

MULTI-FUNCTION METER	20
TRANSMITTING	20
SELECTING TRANSMISSION POWER	20
MICROPHONE GAIN	21

CHAPTER 5 MENU SETUP

WHAT IS A MENU?	22
MENU A/ MENU B	22
MENU ACCESS	22
QUICK MENU	22
PROGRAMMING THE QUICK MENU	22
USING THE QUICK MENU	22
MENU CONFIGURATION	23
ALPHABETICAL FUNCTION LIST	26

CHAPTER 6 BASIC COMMUNICATIONS

SSB TRANSMISSION	27
FM TRANSMISSION	27
AM TRANSMISSION	28
NARROW BANDWIDTH FOR FM	28
NARROW BANDWIDTH FOR AM	28
CW TRANSMISSION	29
AUTO ZERO-BEAT	29
TX SIDETONE/ RX PITCH FREQUENCY	29

CHAPTER 7 ENHANCED COMMUNICATIONS

SPLIT-FREQUENCY OPERATION	30
TF-SET (TRANSMISSION FREQUENCY SET)	30
FM REPEATER OPERATION	31
TRANSMITTING A TONE	32
Activating the Tone Function	32
Selecting a Tone Frequency	32
TONE FREQ. ID SCAN	32
FM CTCSS OPERATION	33
CTCSS FREQ. ID SCAN	33

CHAPTER 8 COMMUNICATING AIDS

RECEPTION	34
SELECTING YOUR FREQUENCY	34
Direct Frequency Entry	34
Using the MHz key	34
Quick QSY	34
Configuring the Tuning control as MULTI control (FM)	34
Fine Tuning	35
Tuning control adjustment rate	35
Equalizing VFO Frequencies (A=B)	35
RIT (RECEIVE INCREMENTAL TUNING)	35
AGC (AUTOMATIC GAIN CONTROL)	35
TRANSMISSION	36
VOX (VOICE-OPERATED TRANSMIT)	36
Microphone Input Level	36
Delay Time	36
Anti-VOX Adjustment	36
VOX Source	36
SPEECH PROCESSOR	37
XIT (TRANSMIT INCREMENTAL TUNING)	37
CUSTOMIZING TRANSMISSION SIGNAL CHARACTERISTICS	38

TX Filter Bandwidth (SSB/ AM)	38
TX Equalizer (SSB/ FM/ AM)	38
TRANSMIT INHIBIT	38
BUSY LOCKOUT	38
CHANGING FREQUENCY WHILE TRANSMITTING	38
CW BREAK-IN	39
USING SEMI BREAK-IN OR FULL BREAK-IN	39
ELECTRONIC KEYS	39
CHANGING KEYING SPEED	39
AUTO WEIGHTING	39
Reverse Keying Weight Ratio	39
BUG KEY FUNCTION	40
CW MESSAGE MEMORY	40
Storing CW Messages	40
Checking CW Messages without Transmitting	40
Transmitting CW Messages	40
Changing the Inter-message Interval Time	41
Changing the Sidetone Volume	41
Inset Keying	41
FREQUENCY CORRECTION FOR CW	41
AUTO CW TX IN SSB MODE	41
MIC UP/ DWN KEY PADDLE MODE	41
SWAP DOT AND DASH PADDLE POSITION	41

CHAPTER 9 SPECIALIZED COMMUNICATIONS

RADIO TELETYPE (RTTY)	42
AMTOR/ PacTOR/ CLOVER/ G-TOR/ PSK31	43
PACKET RADIO	43
SLOW SCAN TV/ FACSIMILE	44

CHAPTER 10 REJECTING INTERFERENCE

IF FILTER	45
CHANGING THE IF FILTER BANDWIDTH	45
SSB/ AM	45
CW/ FSK	45
FM	45
IF SHIFT (SSB/ CW/ FSK)	45
DSP FILTERS	
CHANGING THE DSP FILTER BANDWIDTH	46
SSB/ FM/ AM	46
CW/ FSK	46
BEAT CANCEL (SSB/ FM/ AM)	47
NOISE REDUCTION (ALL MODES)	47
Setting the NR1 Level Adjustment	47
Setting the NR2 Time Constant	47
NOISE BLANKER	47
DIGITAL NOISE LIMITER (DNL)	47
DSP FILTER FOR DATA COMMUNICATION (SSB/ FM)	48
DSP RX MONITOR	48
PRE-AMPLIFIER	49
ATTENUATOR	49
CW REVERSE	49

CHAPTER 11 MEMORY FEATURES

MEMORY CHANNELS	50
-----------------------	----

STORING DATA IN MEMORY	50
Simplex Channels	50
Split-Frequency Channels	51
MEMORY RECALL AND SCROLL	51
Memory Recall	51
Memory Scroll	52
Temporary Frequency Changes	52
MEMORY TRANSFER	52
Memory ➔ VFO Transfer	52
Channel ➔ Channel Transfer	52
STORING FREQUENCY RANGES	53
Confirming Start/End Frequencies	53
Programmable VFO	54
MEMORY CHANNEL LOCKOUT	54
ERASING MEMORY CHANNELS	54
MEMORY CHANNEL NAME	54
QUICK MEMORY	55
STORING INTO QUICK MEMORY	55
RECALLING QUICK MEMORY CHANNELS	55
TEMPORARY FREQUENCY CHANGES	55
QUICK MEMORY ➔ VFO TRANSFER	55

CHAPTER 12 SCAN

NORMAL SCAN	56
VFO SCAN	56
PROGRAM SCAN	56
PROGRAM SCAN PARTIALLY SLOWED	57
SCAN HOLD	57
MEMORY SCAN	58
SCAN RESUME METHOD	58
ALL-CHANNEL SCAN	58
GROUP SCAN	59
Memory Group	59
Scan Group Select	59
Performing Group Scan	59

CHAPTER 13 OPERATOR CONVENIENCES

ANTENNAS	60
APO (Auto Power OFF)	60
AUTOMATIC ANTENNA TUNER	60
PRESETTING	61
EXTERNAL ANTENNA TUNER TYPE	61
ATTENUATOR	61
AUTO MODE	61
BEEP FUNCTION	62
DISPLAY	63
BRIGHTNESS	63
KEY ILLUMINATION	63
LINEAR AMPLIFIER CONTROL	63
LOCK FUNCTIONS	63
FREQUENCY LOCK FUNCTION	63
TUNING CONTROL LOCK FUNCTION	63
MICROPHONE PF KEYS	64
PF KEY	64
RX DSP EQUALIZER	64
EQUALIZING RECEIVING AUDIO	64
RX MONITOR	64

CONTENTS

TIME-OUT TIMER	65	YF-107C/ CN/ SN IF FILTERS AND SO-3 TCXO	81
TRANSVERTER	65	REFERENCE FREQUENCY CALIBRATION	82
FREQUENCY DISPLAY	65	CHAPTER 16 TROUBLESHOOTING	
TRANSMISSION OUTPUT POWER	65	GENERAL INFORMATION	83
TX MONITOR	65	SERVICE	83
TX POWER	65	SERVICE NOTE	83
TX TUNE	66	CLEANING	83
QUICK DATA TRANSFER	67	BACKUP BATTERY	83
SETTING UP	67	TROUBLESHOOTING	84
Equipment Needed	67	MICROPROCESSOR RESET	88
Connections	67	INITIAL SETTINGS	88
USING QUICK TRANSFER	67	PARTIAL RESET	88
Transferring Data	67	FULL RESET	88
Receiving Data	67	DEMONSTRATION MODE	88
COMPUTER CONTROL	68	OPERATION NOTICES	89
SETTING UP	68	DC POWER SUPPLY	89
Equipment Needed	68	FAN NOISES	89
Connections	68	INTERNAL BEATS	89
COMMUNICATION PARAMETERS	68	AGC	89
CONTROLLING THE TS-480 FROM PC	68	60 m BAND OPERATION (K-TYPE/ USA ONLY)	89
REMOTE CONTROLLING THE TS-480 ON THE NETWORK	68	CHAPTER 17 OPTIONAL ACCESSORIES	
VGS-1 VOICE GUIDE AND STORAGE UNIT (OPTIONAL)	68	OPTIONAL ACCESSORIES	90
RECORDING MESSAGES	68	CHAPTER 18 SPECIFICATIONS	
MESSAGE PLAYBACK	69	SPECIFICATIONS	91
Checking Messages	69	CHAPTER 19 INDEX	
Sending Messages	69	INDEX	93
Erasing a Recorded Message	69		
Changing Inter-message Interval Time	69		
Changing Playback Volume	69		
CONSTANT RECORDING	69		
VOICE GUIDE	70		
Voice Guide Announcement Volume	71		
Voice Guide Announcement Speed	71		
DX PACKETCLUSTER TUNE	72		
SKY COMMAND II (K-TYPE ONLY)	73		
SKY COMMAND II DIAGRAM	73		
PREPARATION	73		
CONTROL OPERATION	73		
USING THE TH-D7A AS A COMMANDER	74		
CONTROL OPERATION	74		
CHAPTER 14 CONNECTING PERIPHERAL EQUIPMENT			
COMPUTER	76		
COMPATIBLE TRANSCEIVER	76		
RTTY OPERATION	77		
HF/ 50 MHz LINEAR AMPLIFIER	77		
ANTENNA TUNER	78		
MCP AND TNC	78		
DX PACKETCLUSTER TUNE	79		
CROSSBAND REPEATER	79		
SKY COMMAND II (K-TYPE ONLY)	80		
CHAPTER 15 INSTALLING OPTIONS			
REMOVING THE TOP COVER	81		
VGS-1 VOICE GUIDE AND STORAGE UNIT	81		

INSTALLATION

MOBILE INSTALLATION

When you use this transceiver for mobile operation, do not attempt to perform any kind of configuration or menu setup configuration while driving your car; it is simply too dangerous. Stop the car and then perform transceiver configuration. In addition, do not wear headphones while driving.

You should install the transceiver in a safe and convenient position inside your vehicle so as not to subject yourself to danger while driving. For example, install the transceiver under the dash in front of the passenger seat so that knees or legs will not strike the transceiver if you brake suddenly. Additionally, do not install the transceiver and its accessories on to the air bag lids. We recommend you consult your car dealer for the transceiver installation to ensure safety.

INSTALLATION EXAMPLE

- 1 Attach the 2 L-brackets using the 6 supplied SEMS screws (M4 x 10 mm) as shown below.
- 2 Position the transceiver in the mounting bracket and tighten the 4 supplied tapping screws (5 mm x 16 mm) to fix the transceiver in place.

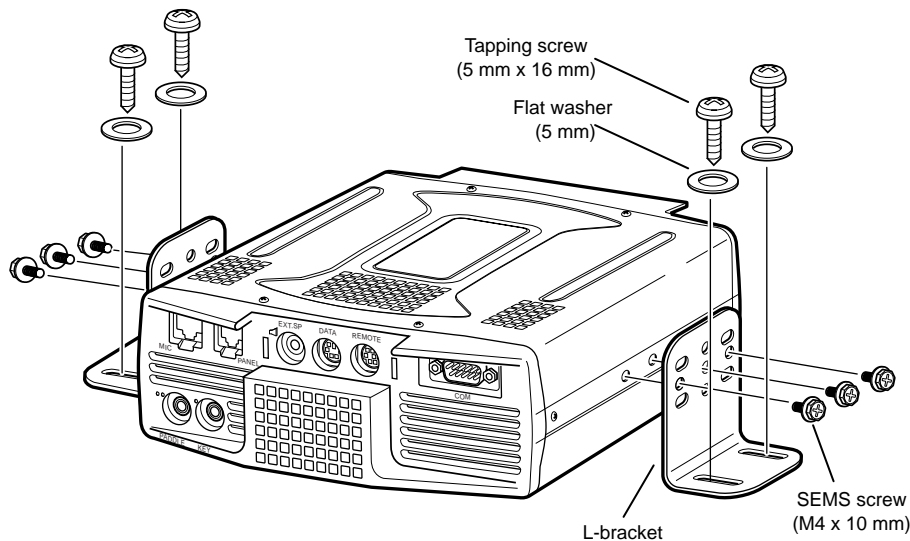

Do not install the TX/RX unit in non-ventilated areas. Air must flow through the TX/RX unit to keep the unit cooled.

REMOTE CONTROL PANEL INSTALLATION

- 1 Peel off the adhesive tape cover from the bottom of the fan-shaped base.
- 2 Afix the holder to the vehicle with 4 tapping screws.
- 3 Attach the Remote Control panel holder to the base with 2 supplied SEMS screws.

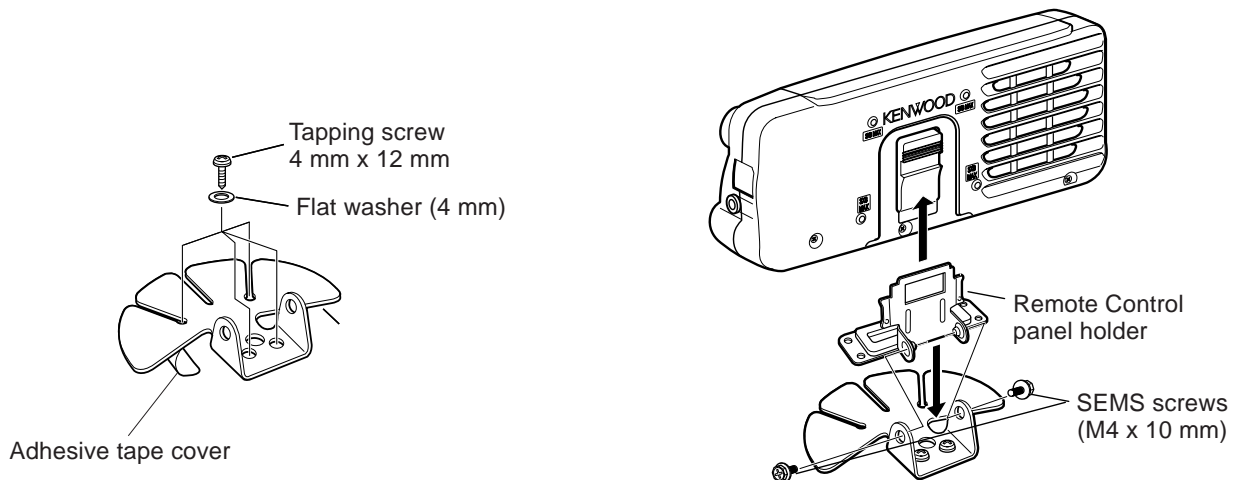

1 INSTALLATION

DC POWER CABLE CONNECTION

Connect the DC power cable directly to the vehicle's battery terminals using the shortest route. Do not use the cigarette lighter socket! The current rating of the cigarette lighter socket is too small to operate the transceiver. Ensure to use a 12 V vehicle battery which has sufficient current capacity. If the current is insufficient, the display may darken during transmission or the transceiver may work intermittently. If you use the transceiver for a long period when the vehicle battery has not been fully charged or when the engine has been stopped, the battery may become discharged in a short time and will not have sufficient reserves to start the engine. Avoid using the transceiver under these conditions. Keep in mind that the TS-480SAT transceiver draws a peak current of approximately 20.5 A and the TS-480HX transceiver draws a peak current of approximately 41A (20.5A + 20.5A) during transmission.

- Attach the line filter(s) to the DC cable(s) as shown after the installation (E-type only).

Note:

- ◆ Do not use two separate batteries to connect each DC cables from the transceiver (TS-480HX). The DC voltage difference between DC IN 1 and DC IN 2 connectors at the transceiver must be within DC 1.0 V to operate the transceiver.
- ◆ Two supplied DC cables (or two optional PG-20 DC cables) must be used. Using different length and/or different gauged cable could result in a voltage difference between DC IN 1 and DC IN 2 connectors at the transceiver (TS-480HX).

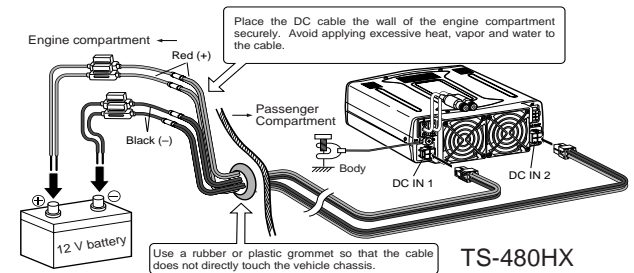
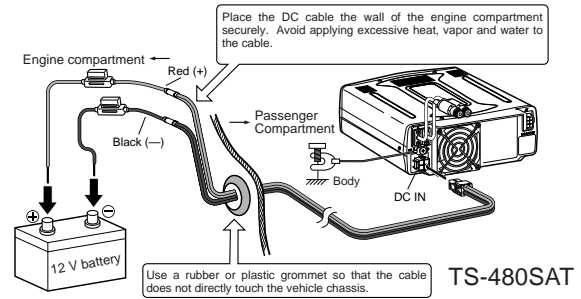

E-type only

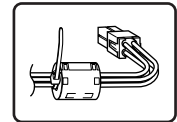

ANTENNA CONNECTION

In general, HF/ 50 MHz mobile antennas are larger and heavier than VHF/ UHF antennas. Therefore, use a strong and rigid mount to safely and securely install the HF/ 50 MHz mobile antenna.

A bumper mount is recommended for stable mounting. However, most recent models of vehicles have plastic bumpers. For such vehicles, ground the antenna mount to the body chassis with a large wire. Antenna installation is critical for successful mobile operation. For further information, refer to The Radio Amateur's Handbook, Radio Handbook, or other published texts.

GROUND CONNECTION

The ground, which is the other half of the antenna system, is very important when using a mobile whip type antenna. Connect the feed line ground for the antenna securely to the vehicle's chassis, and be certain to bond (electrically connect) the vehicle's body to chassis. The sheet metal will provide the primary ground plane, so be sure to establish a good RF connection from the feed line to both the chassis and the body. For comprehensive information on mobile antennas installations and optimization, refer to the ARRL Handbook or similar publications.

IGNITION NOISE

This transceiver has been equipped with a Noise Blanker and Digital Noise Limiter to filter ignition noises out. However, some cars may generate excessive ignition noise. If there is excessive noise, use suppressor spark plugs (with resistors), and/ or DC line filters to reduce the electric noises. The ARRL Handbook, or similar references, has a wealth of information regarding this topic.

Note:

- ◆ After installation and wiring are completed, confirm that all work has been done correctly, then connect the DC power cable plug(s) to the transceiver.
- ◆ If the fuse blows, disconnect the DC power cable plug(s) from the transceiver immediately, then check all the DC power cables to find the reasons of the short circuit. The DC cable may be damaged, short circuited, pinched, or squashed. After resolving the problem, replace the fuse with one of the same type and rating.
- ◆ Do not remove the fuse holder for any reason.

FIXED STATION INSTALLATION

When you use the transceiver at a fixed location, the transceiver requires 13.8 V DC power supply (The TS-480HX requires 2 DC power supplies).

REMOTE CONTROL PANEL INSTALLATION

- 1 Attach the oval-shaped base to the front panel mounting bracket using two SEMS screws (M4 x 10 mm) as shown below.
- 2 Slide the Remote Control panel along the mounting bracket rails until secure.

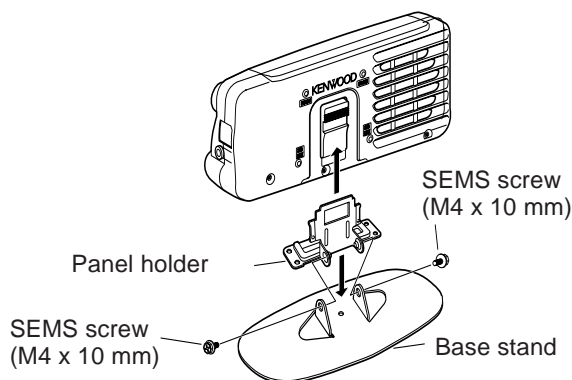

DC POWER SUPPLY CONNECTION

In order to use this transceiver, you need a separate 13.8 V DC power supply (two 13.8 V/ 20.5 A or single 13.8 V/ 41.0 A DC power supply(s) is required to transmit for the TS-480HX) that must be purchased separately. Do not directly connect the transceiver to an AC outlet. Use the supplied DC power cables to connect the transceiver to a regulated power supply. Do not substitute a cable with smaller gauge wires. The current capacity of each power supply must be 20.5 A peak or more.

- 1 Connect the DC power cable(s) to the regulated DC power supply (two 13.8 V/ 20.5 A or single 13.8 V/ 41.0 A DC power supply(s) must be used for the TS-480HX); the red lead to the positive terminal and the black lead to the negative terminal.
 - When using a single 13.8 V/ 41 A DC power supply, connect 2 DC cables to the positive and negative terminals, as shown on page 2.
- 2 Connect the DC power cable to the transceiver's DC power connector.
 - Press the connectors firmly until the locking tab clicks.
 - Attach the line filter(s) to the DC cable(s) as shown below (E-type only).

Note:

- ◆ Before connecting the DC power supply to the transceiver, be sure to switch OFF the DC power supply and the transceiver.
- ◆ Do not plug the DC power supply into an AC outlet until you make all connections.
- ◆ When two power supplies are used for the TS-480HX, the DC voltage difference at the transceiver DC IN connectors must be within 1.0 V DC.
- ◆ Do not use different types (length and gauge) of DC cables to avoid voltage differences (TS-480HX).

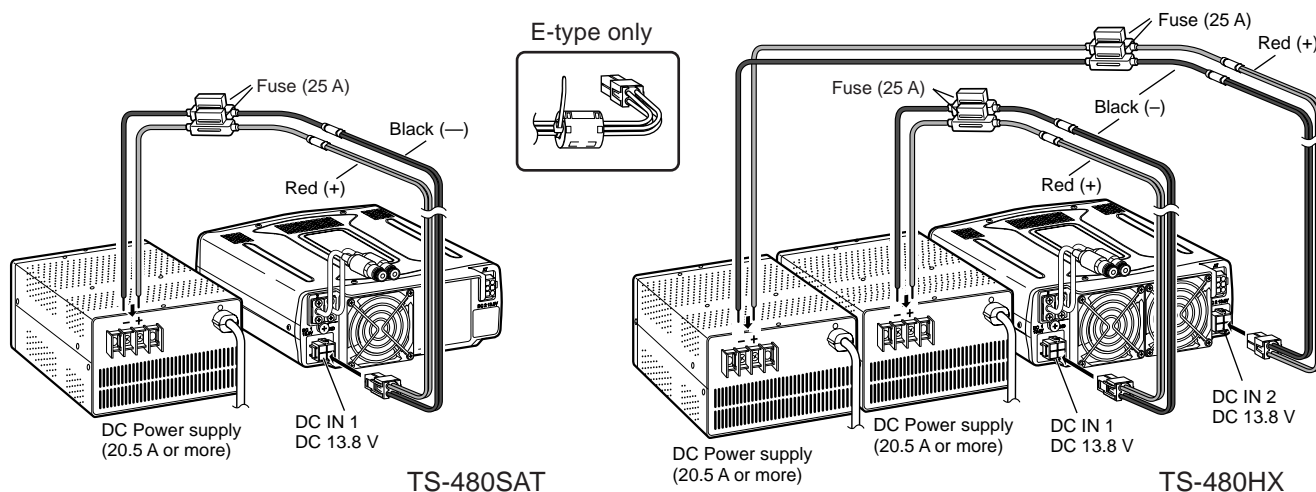

1 INSTALLATION

ANTENNA CONNECTION

An antenna system consists of an antenna, feed line, and ground. The transceiver can give excellent results if the antenna system and its installation are given careful attention. Use a properly adjusted 50 Ω antenna of good quality, a high-quality 50 Ω coaxial cable, and first-quality connectors. All connections must be clean and tight.

After making the connections, match the impedance of the coaxial cable and antenna so that the SWR is 1.5:1 or less. High SWR will cause the transmit output to drop and may lead to radio frequency interference to consumer products such as stereo receivers and televisions. You may even interfere with your own transceiver. Reports that your signal is distorted could indicate that your antenna system is not efficiently radiating the transceiver's power.

Connect your primary HF/ 50 MHz antenna feed line to ANT 1 on the rear of the transceiver. If you are using two HF/ 50 MHz antennas, connect the secondary antenna to ANT 2. Refer to page 16 for the location of the antenna connectors.

Note:

- ◆ *Transmitting without connecting an antenna or other matched load may damage the transceiver. Always connect the antenna to the transceiver before transmitting.*
- ◆ *All fixed stations should be equipped with a lightning arrester to reduce the risk of fire, electric shock, and transceiver damage.*
- ◆ *The transceiver's protection circuit will activate when the SWR is greater than 2.5:1; however, do not rely on protection to compensate for a poorly functioning antenna system.*

GROUND CONNECTION

At the minimum, a good DC ground is required to prevent such dangers as electric shock. For superior communications results, a good RF ground is required against which the antenna system can operate. Both of these conditions can be met by providing a good earth ground for your station. Bury one or more ground rods or a large copper plate under the ground, then connect this to the transceiver GND terminal. Use heavy gauge wire or a copper strap, cut as short as possible, for this connection. Do not use a gas pipe, an electrical conduit, or a plastic water pipe as a ground.

LIGHTNING PROTECTION

Even in areas where lightning storms are less common, there are usually a limited number of storms each year. Consider carefully how to protect your equipment and home from lightning. The installation of a lightning arrester is a start, but there is more that you can do. For example, terminate your antenna system transmission lines at an entry panel that you install outside your home. Ground this entry panel to a good outside ground, then connect the appropriate feed lines between the entry panel and your transceiver. When a lightning storm occurs, disconnecting the feed lines from your transceiver will ensure additional protection.

PORTABLE BRACKET (E-TYPE ONLY)

Using the supplied Portable Bracket, you can carry the Remote Control panel and TX/ RX unit together. Two TX/ RX unit positions are available. If you do not use the **EXT.SP**, **REMOTE** and **DATA** connectors, place the TX/ RX unit in front position. If you use the **EXT.SP**, **REMOTE** or **DATA** connector, place the TX/ RX unit to the back position. You can also attach the handle as shown if necessary. Use the supplied short cable (RJ11/ 20 cm) to connect the Remote Control panel and the TX/ RX unit.

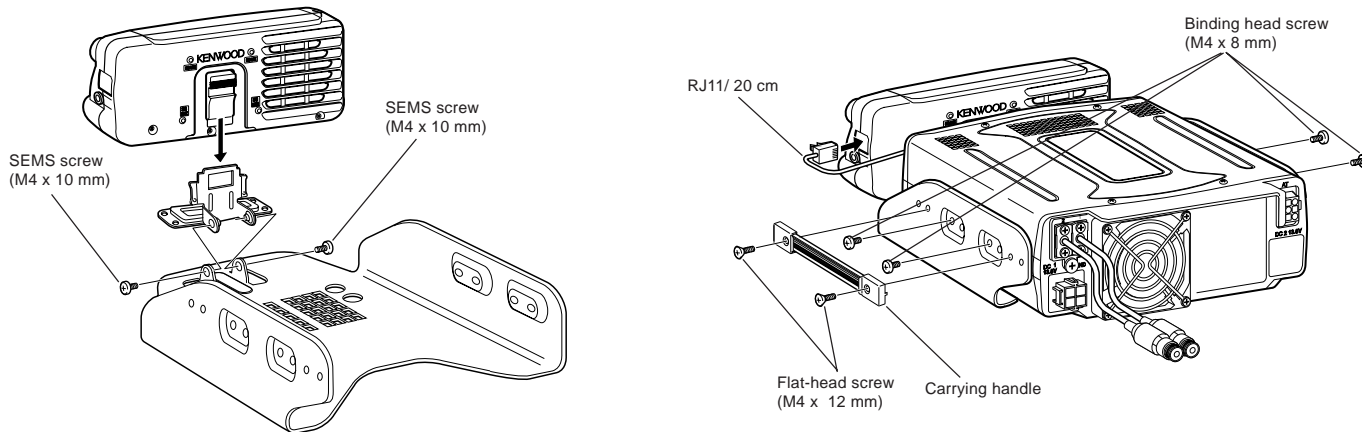

FUSES

The following fuses are used in the TS-480HX/ SAT transceiver. If a fuse blows, determine the cause then correct the problem. Only after the problem has been resolved, replace the blown fuse with a new one with the specified ratings. If newly installed fuses continue to blow, disconnect the power plug and contact a **KENWOOD** service center or your dealer for assistance.

- 1 Remove 7 screws at the bottom of the TX/ RX unit.
- 2 Remove 8 screws inside of the TX/ RX unit.
- 3 Lift the shield cover.
- 4 Replace 4 A fuse.

Fuse Location	Fuse Current Rating
TS-480HX/ SAT (TX/ RX unit)	4 A (For an external antenna tuner)
Supplied DC power cable	25 A

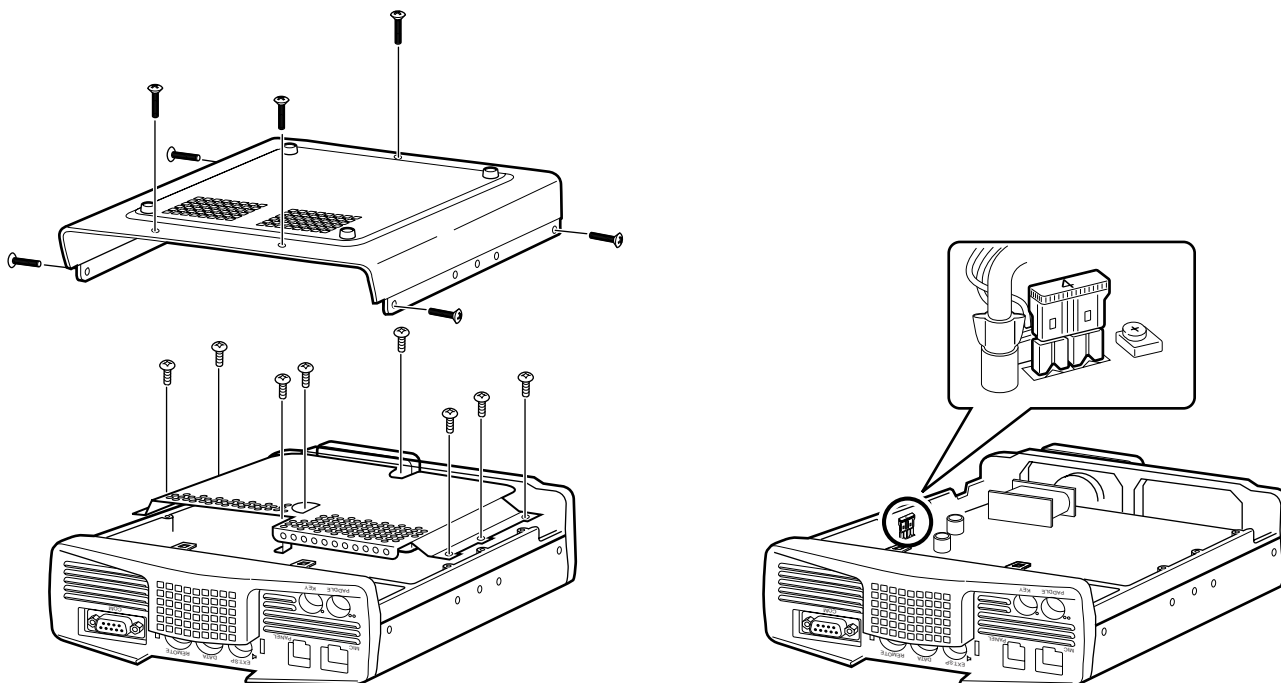

1 INSTALLATION

PANEL AND MICROPHONE CONNECTION

Plug the microphone plug to the MIC jack (8-wire/ RJ45), then connect the Remote Control panel to the TX/ RX unit with the supplied cable (2 m/ 6-wire/ RJ11).

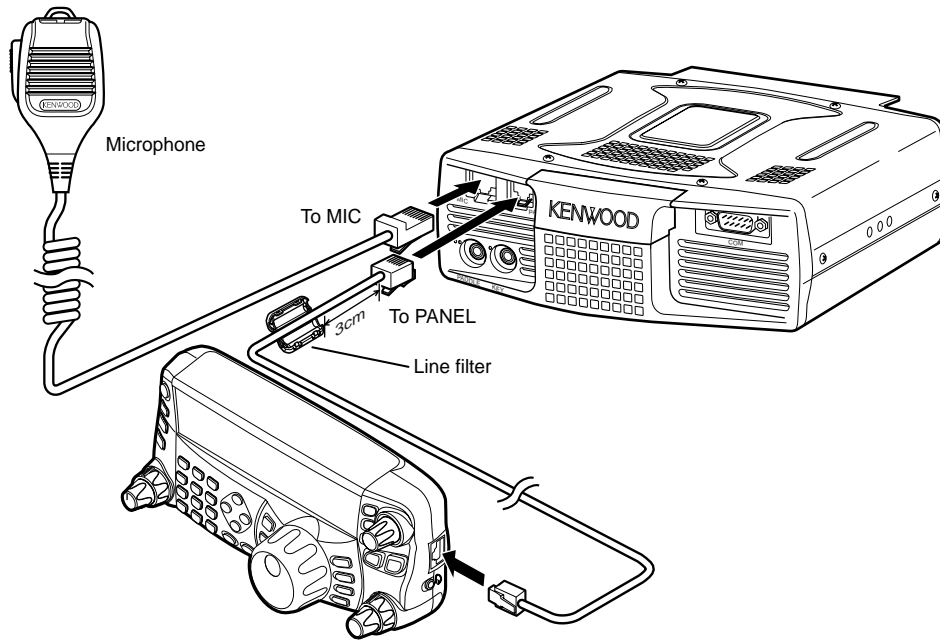

PANEL AND MICROPHONE CONNECTION USING PG-4Z (OPTION)

Use the cables and connectors to connect the Remote Control panel and TX/ RX unit with the PG-4Z cable kit as shown below.

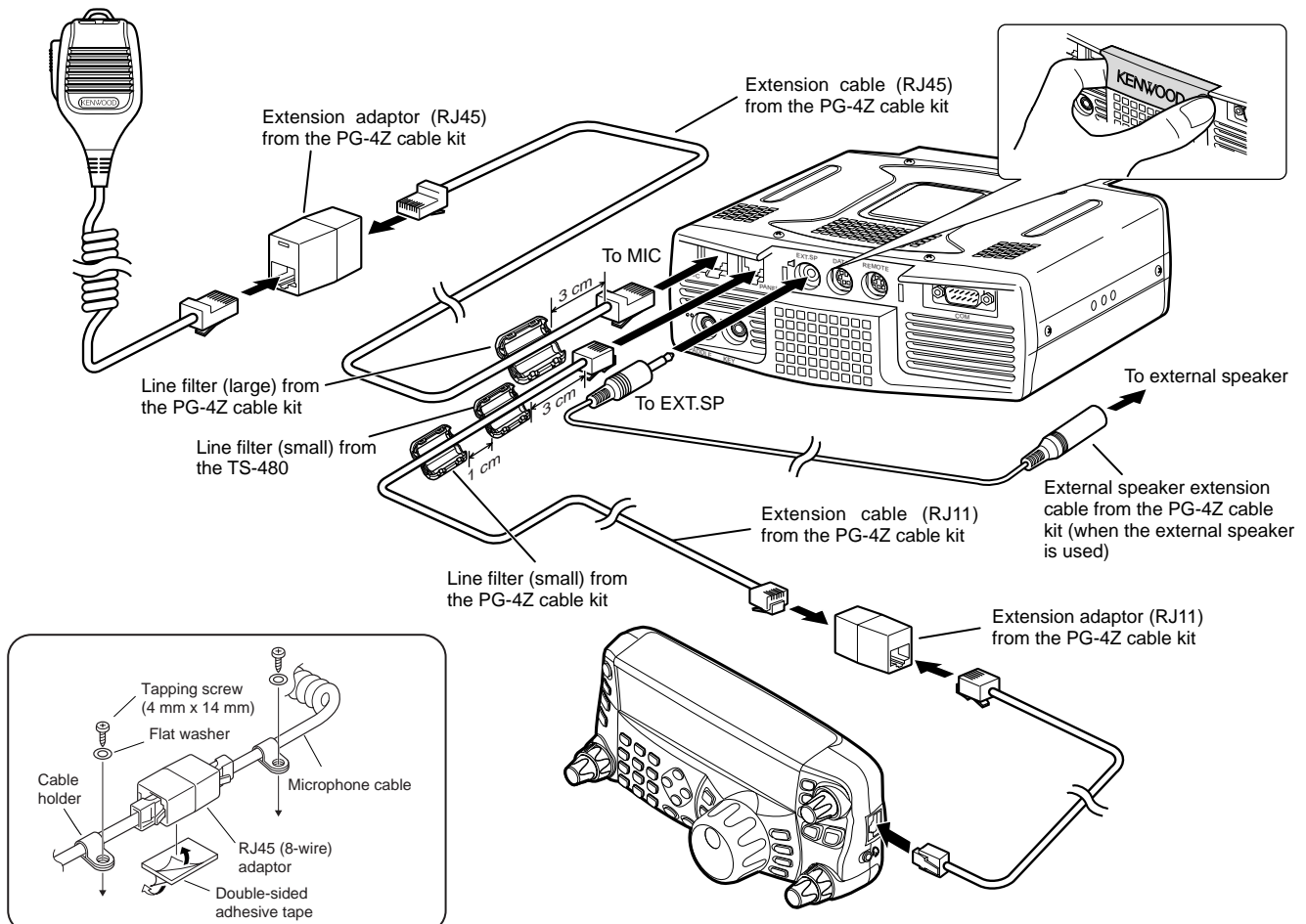

ACCESSORY CONNECTIONS

TX/ RX UNIT

■ Microphone (MIC)

Connect a microphone having an impedance between 250 and 600 Ω . As for the supplied microphone, fully insert the modular connector into the **MIC** jack until the locking tab clicks. You can still utilize 8-pin metal type plug microphones, such as MC-43S, MC-47, and MC-60A with the optional MJ-88 adaptor (optional) if necessary. However, do not use the MC-44, MC-44DM, MC-45, MC-45E, MC-45DM, MC-45DME, or MC-53DM condenser-type microphones.

■ External Speaker (EXT.SP)

On the front panel of the TX/ RX unit, there is an external speaker jack. If an external speaker is connected to **EXT.SP** jack, the built-in speaker on the back of the Remote Control panel will mute. Use only external speakers with an impedance of 4 to 8 Ω (8 Ω nominal). The jacks accept only 3.5 mm (1/8") diameter, 2-conductor (mono) plugs.

- The "▲" projection indicates the external speaker jack.

Note: Do not connect headphones to this jack. The high audio output of this jack could damage your hearing.

■ Keys for CW (PADDLE and KEY)

For CW operation using the internal electronic keyer, connect a keyer paddle to the **PADDLE** jack. For CW operation without using the internal electronic keyer, connect a straight key, semi-automatic key (bug), electronic keyer, or the CW keying output from a Multi-mode Communications Processor (MCP) to the **KEY** jack. The **PADDLE** and **KEY** jacks mate with a 3.5 mm (1/8") 3-conductor plug and a 3.5 mm (1/8") 2-conductor plug respectively. External electronic keyers or MCPs must have a positive keying output to be compatible with this transceiver. Use a shielded cable between the key and the transceiver.

- The "●" projection indicates the key jack and the "●●" projection indicates the paddle jack.

Note: Due to the functionality of the internal electronic keyer, you may find it unnecessary to connect both a paddle and another type of keyer unless you want to use a PC-based keyer for CW. Refer to the "ELECTRONIC KEYER" section (page 39) to become familiar with the internal keyer.

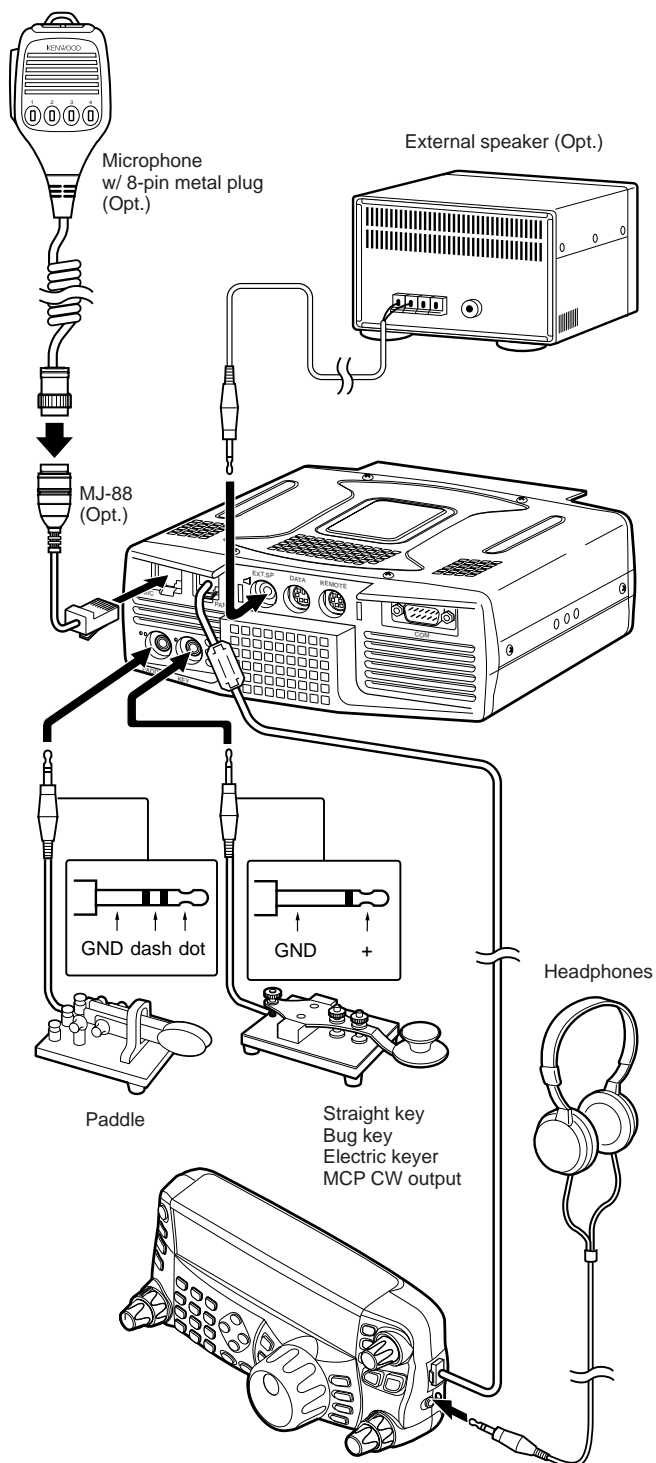

REMOTE CONTROL PANEL

■ Headphones (PHONES)

Connect monaural or stereo headphones having a 4 to 32 Ω impedance. This jack accepts a 3.5 mm (1/8") diameter, 2-conductor (mono) or 3-conductor (stereo) plug. After connecting the headphones, you will hear no sound from the internal (or optional external) speaker.

RECEPTION

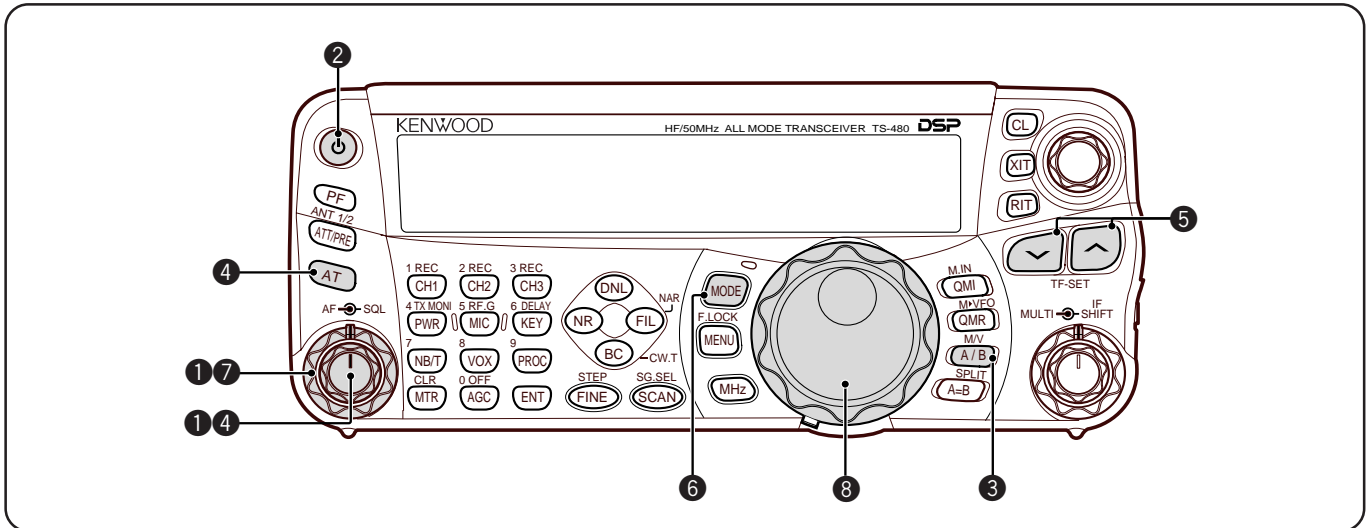

Are you ready to give your TS-480HX/ SAT a quick try? Reading these two pages should get your voice on the air in your first QSO on the HF/ 50 MHz band shortly. The instructions below are intended only for a quick guide. If you encounter problems or there is something you don't understand, read the detailed explanations given later in this manual.

Note: This section explains only keys and controls required to briefly try the transceiver.

1 Set the following as specified:

- **AF** control: Fully counterclockwise
- **SQL** control: Fully counterclockwise

Then, switch ON the DC power supply if you are using the DC power supply. If you are operating the transceiver with the car batteries, ensure that the DC power source(s) are available at the DC connector(s).

2 Press and hold [ϕ] (POWER) briefly to turn ON the transceiver.

- Do not press the switch for more than approximately 2 seconds; the transceiver will be switched OFF.
- Upon power up, "HELLO" appears, followed by the selected frequency and other indicators.

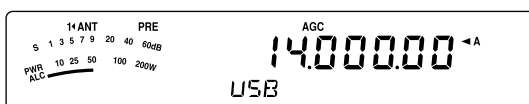
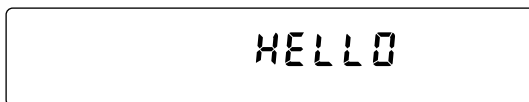

3 Confirm that VFO A has been selected for communications; "◀A" should be visible on the display. If it has not, press [A/B / M/V] to select VFO A.

4 Turn the **AF** control slowly clockwise until you hear a suitable level of background noise.

5 Press [∇] / [\blacktriangle] to select a desired HF/ 50 MHz Amateur radio band.

6 Press [MODE] to select the desired communication mode.

- There are 4 mode pairs: USB/ LSB, CW/ CWR (Reversed pitch), FSK/ FSR (Reverse shift) and AM/ FM. Press [MODE] (1 s) to toggle the mode within each pair: USB ↔ LSB, CW ↔ CWR, FSK ↔ FSR, or AM ↔ FM.
- To select the alternate mode on each operating mode, press and hold the key for 1 second. For example, if USB is selected, press [MODE] (1 s) to switch to LSB mode. The following diagram illustrates how to access each mode.

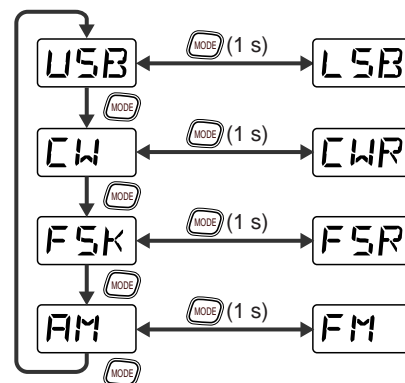

7 If you have selected FM, turn the **SQL** control clockwise until the background noise is just eliminated; the green LED (above the [MODE] key) turns OFF.

- With LSB or USB selected, skip this step.

8 Turn the **Tuning** control to tune in a station.

- If you do not hear any stations, you may have the wrong antenna connector selected. In this case, try selecting another antenna by pressing and hold [ATT/PRE/ ANT1/2] (1 s).

TRANSMISSION

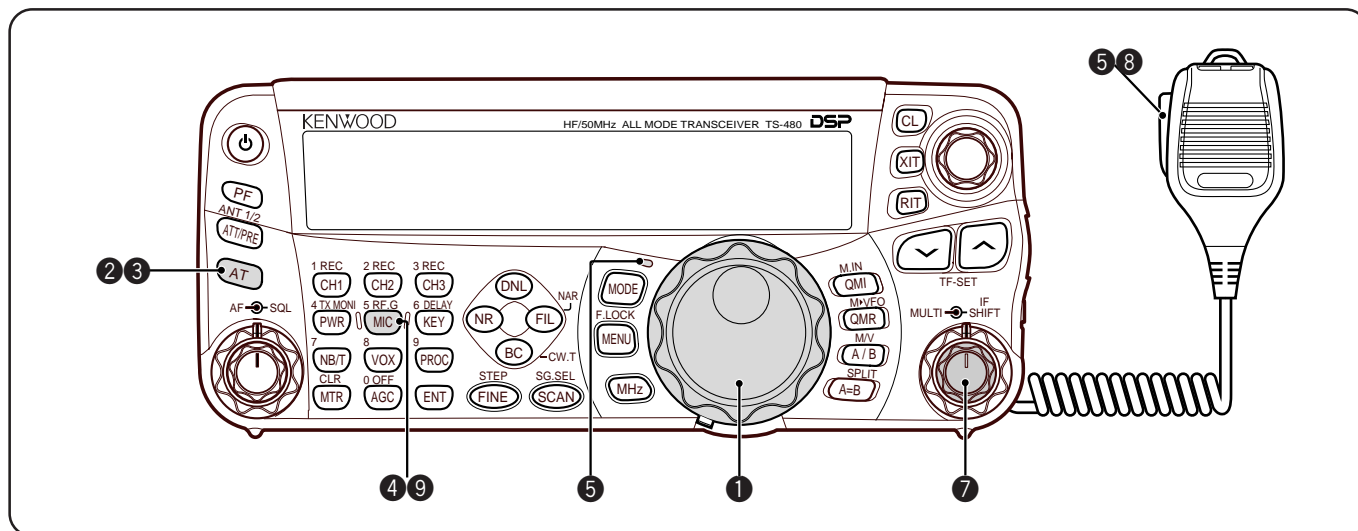

- 1 Turn the **Tuning** control to tune in a desired station or to select an unused frequency.
 - If you are operating the TS-480HX transceiver without the AT-300 antenna tuner, continue to step 4.
- 2 Press **[AT]** momentarily.
 - “**AT▶T**” appears.
- 3 Press and hold **[AT]** to start tuning the antenna tuner (TS-480SAT or TS-480HX with the AT-300 antenna tuner).
 - “**R◀AT▶T**” starts blinking and the LED above the **[MODE]** key turns red.
 - Tuning should be completed in under 20 seconds, then a morse code “T” (a long single beep) sounds and “**AT▶T**” stops blinking.
 - If tuning is not completed within 20 seconds, error beeps sound. Press **[AT]** to stop the error beeps and quit tuning. Check your antenna system before continuing. If you do not press **[AT]**, tuning will continue for approximately 60 seconds.

Note:

- ◆ You will hear a lot of clicking sounds coming from the transceiver or external antenna tuner while the antenna tuner is trying to tune the antenna. This is simply the relay switches turning ON and OFF.
- ◆ When the TS-480HX transceiver is used with the AT-300 external antenna tuner, the TX output power is automatically reduced to 100 watts (AM: 25 watts).

- 4 With LSB, USB, or AM selected, press **[MIC/ 5/ RF.G]** to adjust the Microphone Gain.
 - “MIC -- 50” appears.

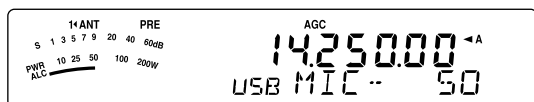

- With FM selected, skip this step.

- 5 Press Mic **[PTT]**.
 - The LED lights red.
- 6 Begin speaking into the microphone in your normal tone of voice.
- 7 LSB/ USB: While speaking into the microphone, adjust the **MULTI** control so that the ALC meter reflects according to your voice level.

AM: While speaking into the microphone, adjust the **MULTI** control so that the power meter slightly reflects to your voice level.

FM: Skip this step.
- 8 When you finish speaking, release Mic **[PTT]** to return to receive mode.
- 9 Press **[MIC/ 5/ RF.G]** to finish adjusting the Microphone Gain.

Note: If desired, access Menu No. 44 {page 27} to adjust the Microphone Gain for FM mode.

This completes your introduction to the TS-480 transceiver, but there is a great deal more to know. “OPERATING BASICS” {page 18} and the following chapters explain all the functions of this transceiver, starting with the most basic, commonly-used functions.

GETTING ACQUAINTED

REMOTE CONTROL PANEL

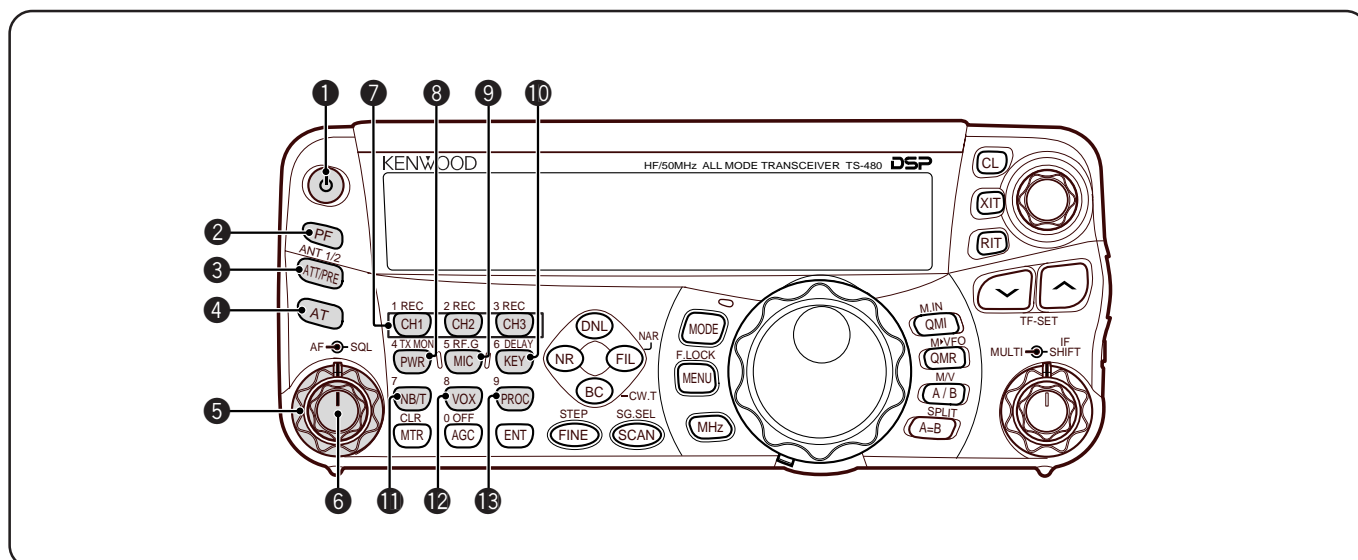

❶ [⏻] (POWER) switch

Press and hold briefly to switch the transceiver power ON. Press again to switch the power OFF {page 18}.

❷ PF key

You can assign a function to this Programmable Function key. The default function is VOICE1. To use the Voice Guide and Storage functions, the optional VGS-1 is required {page 64}.

❸ ATT/PRE/ ANT1/2 key

Press to cycle between receiver attenuator ON, pre-amplifier ON and OFF {pages 49, 61}. Press and hold for 1 second, then release it to select either ANT 1 or ANT 2 {page 60}.

❹ AT

Press to activate the internal antenna tuner {page 60} or an external antenna tuner. Press and hold to start tuning the automatic antenna tuner.

❺ SQL control

Used for muting (“squenching”) the speaker, the headphones and the AF output on DATA (8-pin mini DIN connector) when no receive signal is present on the transceiver {page 19}.

❻ AF control

Turn to adjust the audio volume on the transceiver {page 18}.

❼ CH1/ 1/ REC, CH2/ 2/ REC, CH3/ 3/ REC key

Press to play back the CW or voice messages (the VGS-1 is required) {page 40}. Press and hold to record the voice messages (the VGS-1 is required) {page 68} or CW messages that are associated with the internal electronic keyer {page 40}.

❽ PWR/ 4/ TX MONI key

Press to adjust the transmission output power. Press and hold to adjust the volume of the transmission signal monitor function {page 65}.

❾ MIC/ 5/ RF.G key

Press to adjust the microphone gain {page 27}. While the Speech Processor function is ON, press to adjust the Speech Processor output level {page 37}. Press and hold to adjust the receiver RF gain {page 18}.

❿ KEY/ 6/ DELAY key

Press to adjust the internal electronic keyer speed. Press and hold to adjust the VOX delay time {page 36} or Break-in time (Full Break-in/ Semi Break-in time) for CW mode {page 39}.

⓫ NB/T/ 7 key

Press to switch the Noise Blanker ON or OFF. Press and hold to adjust the Noise Blanker level {page 47}. In FM mode, press to turn the Tone function ON or OFF {page 32}. Press and hold to select a sub-audible tone for the Tone function {page 32}.

⓬ VOX/ 8 key

In voice mode, press to turn the VOX (Voice-Operated Transmit) function ON or OFF {page 36}. In CW mode, press to turn the Break-in function ON or OFF {page 39}. Press and hold to adjust the microphone input gain for VOX operation. The VOX icon appears when the VOX (Voice)/ Break-in (CW) function is active.

⓭ PROC/ 9 key

Press to turn the Speech Processor ON or OFF {page 37}. Press and hold to adjust the Speech Processor input level. The PROC icon appears when the Speech Processor function is ON.

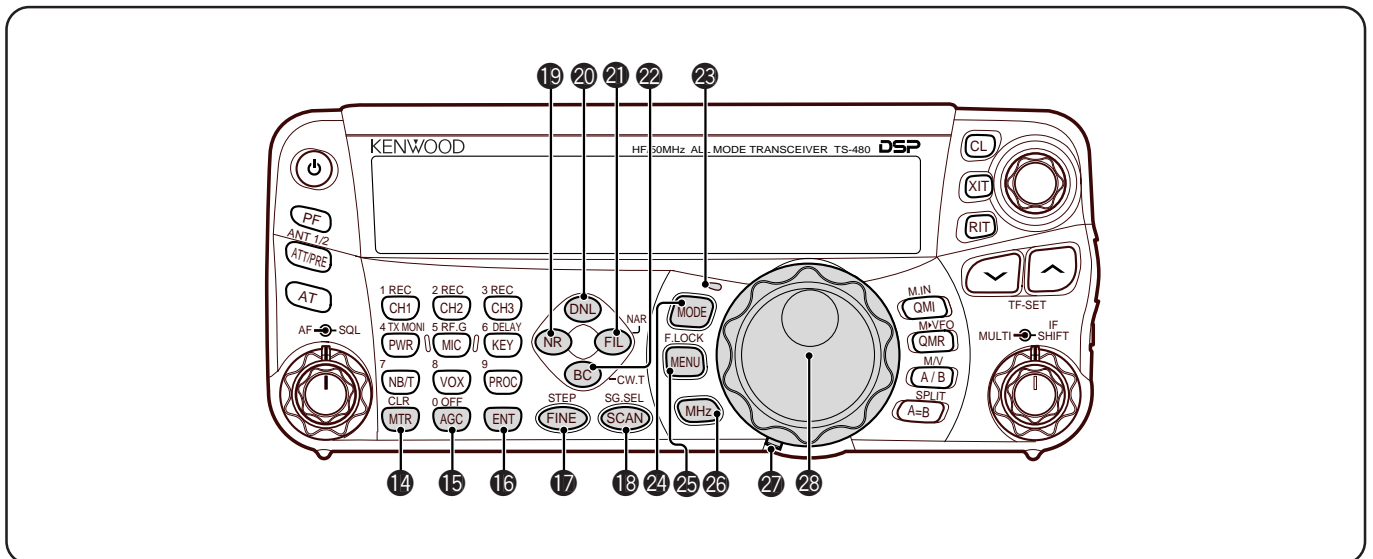

14 MTR/ CLR key

Press to select the meter scales {page 20} or exit from, abort, or reset various functions. Press and hold to clear memory channels {page 54}.

15 AGC/ 0/ OFF key

Press to toggle the fast or slow response time for the Automatic Gain Control (AGC). Press and hold to switch the AGC OFF {page 35}.

16 ENT key

Press to enter your desired frequency using the keypad {page 34} or lock out memory channels from the scan list {page 54}.

17 FINE/ STEP key

Press to activate the Fine tuning function to allow more precise tuning {page 35}. Press and hold to select the frequency step size for the **MULTI** control {page 34}.

18 SCAN/ SG.SEL key

Press to start or stop the Scan function {page 56}. Press and hold to select a Scan group {page 59}.

19 NR key

Press to select the DSP Noise Reduction function, NR1, NR2 or OFF {page 47}. When the Noise Reduction function is turned ON, press and hold key to change the parameter of the Noise Reduction function {page 47}.

20 DNL key

Press to turn the DNL (Digital Noise Limiter) function ON or OFF. The "DNL" icon appears when it is ON. Press and hold the key to change the level of DNL function {page 47}.

21 FIL/ NAR key

Press to configure the low-cut and high-cut filter frequency for the DSP filter (AF). Press and hold to select the narrow IF filter if available {page 45}.

22 BC/ CW.T key

Press to select the DSP Beat Cancel function, BC1 (Beat Cancel 1), BC2 (Beat Cancel 2) or OFF {page 47}. In CW mode, press to start the Auto Zero-beat in CW mode {page 29}.

23 LED

Lights red when the transceiver is transmitting, lights green when the transceiver is receiving signals, and turns OFF when the transceiver mutes with the squelch function.

24 MODE key

Press to change the operating mode pair. There are 4 pairs: USB/ LSB, CW/ CWR, FSK/ FSR, and AM/ FM. Press and hold for a second to toggle the mode within each pair: USB ↔ LSB, CW ↔ CWR, FSK ↔ FSR, or AM ↔ FM {page 19}.

25 MENU/ F.LOCK key

Press to enter Menu mode {page 22}. Press and hold to activate the Frequency Lock function {page 63}.

26 MHz key

Press to turn the MHz Up/ Down function ON or OFF. The MHz digit increases or decreases when you turn the **MULTI** control. Press and hold to change the increment/ decrement step value {page 34}.

27 Tuning control torque adjustment lever

The lever behind the **Tuning** control adjusts the control torque level; turn clockwise for light torque or counterclockwise for heavy torque.

28 Tuning control

Turn to select the desired frequency {page 19}. Use the convenient finger-tip cavity for continuous tuning.

3 GETTING ACQUAINTED

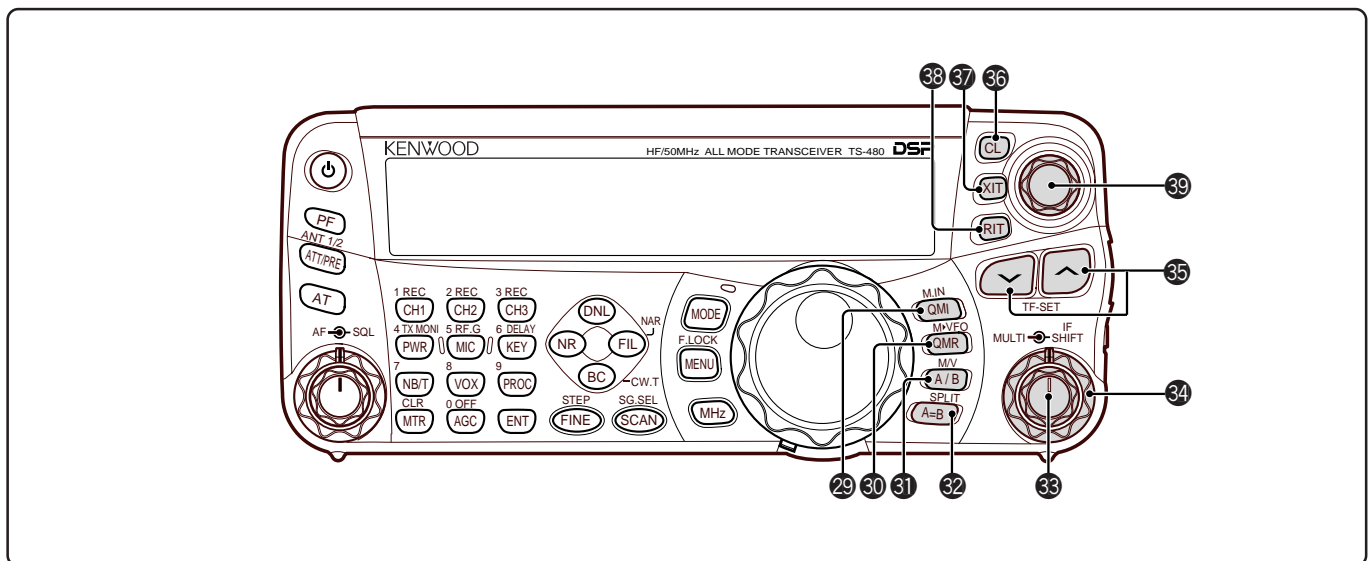

29 QMI/ M.IN key

Press to store data to the Quick Memory. Press and hold to store the current operating frequencies and other data to the Memory channel.

30 QMR/ M>VFO key

Press to recall data from the Quick Memory {page 55}. Press and hold to transfer the Memory Channel frequencies and other data to the VFO.

31 A/B / M/V key

Press to select either VFO A or VFO B {page 18}. Press and hold to toggle between Memory and VFO modes.

32 A=B/ SPLIT key

Press to duplicate the data in the currently selected VFO to the other VFO {page 35}. Press and hold to enter split-frequency operation which allows you to use different transmission and reception frequencies {page 30}.

33 MULTI control

In VFO mode, rotate to step the operating frequency up or down {page 34}. In Memory Channel mode, rotate to select a Memory Channel {page 51}. Also, used for selecting Menu numbers when accessing the Menu mode {page 22} and as a selector to choose settings for various functions activated by Remote Control panel keys.

34 IF SHIFT control

Rotate to shift the center frequency of the IF passband either lower or higher, to remove interference {page 45}.

35 V/ ^ key

Normally, press to step through all the Amateur radio bands consecutively {page 19}. Also used to make selections from the Menu {page 22} and to check the Start and End frequencies of the Scan function {page 53}. When both the split-frequency and the frequency lock function are activated, press and hold to perform the TF-SET function {page 30}.

36 CL key

Press to clear the RIT/ XIT frequency to zero {pages 35, 37}.

37 XIT key

Press to turn the XIT (Transmit Incremental Tuning) function ON or OFF {page 37}. When the XIT function is ON, the XIT icon appears.

38 RIT key

Press to turn the RIT (Receive Incremental Tuning) function ON or OFF {page 35}. When the RIT function is ON, the RIT icon appears.

39 RIT/ XIT control

When the RIT/ XIT function is ON, turn to adjust the offset frequency. The RIT/ XIT offset frequency appears on the sub-display {pages 35, 37}.

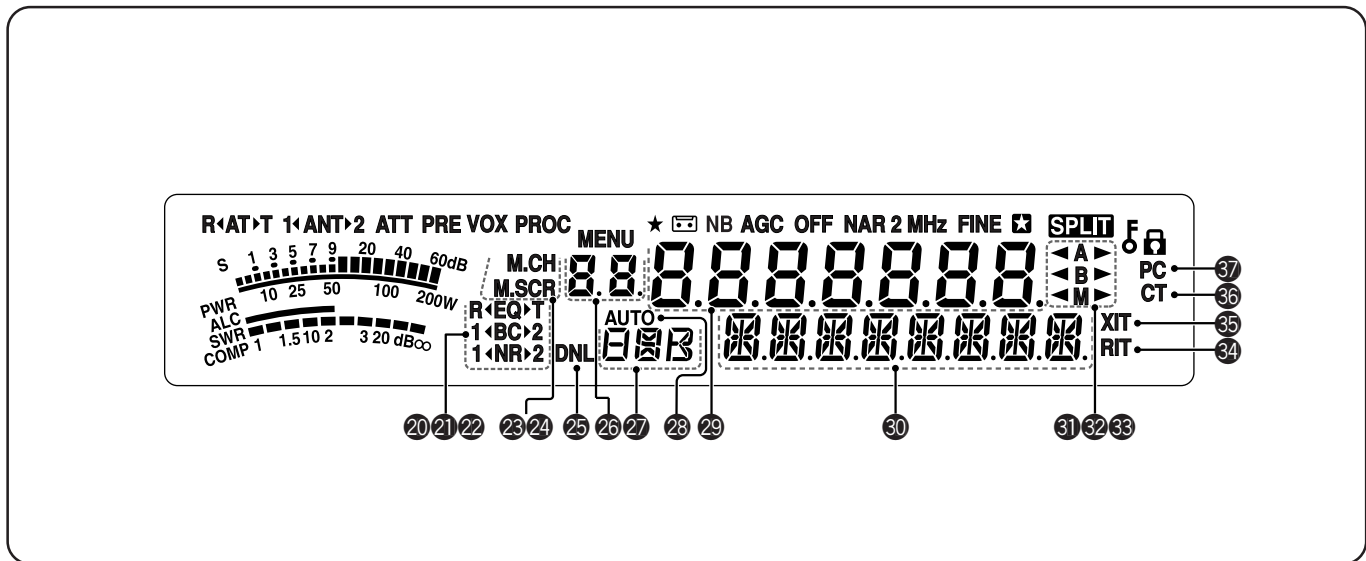

20 R<EQ>T

“R<EQ>” appears when the RX Equalizer function is ON {page 64}. “EQ>T” appears when the TX Equalizer function is ON {page 38}.

21 1<BC>2

“1<BC>” or “BC>2” appears, as you select the DSP Beat Cancel 1 or Beat Cancel 2 {page 47}.

22 1<NR>2

“1<NR>” or “NR>2” appears, depending on whether DSP Noise Reduction 1 (Line Enhanced method) or Noise Reduction 2 (SPAC method) is selected {page 47}.

23 M.CH

Appears in Memory Recall mode {page 51}.

24 M.SCR

Appears in Memory Scroll mode {page 52}.

25 DNL

Appears when the Digital Noise Limiter function is ON {page 47}.

26 8.8

Shows the Memory Channel number for the transceiver. In Menu mode, it displays the Menu No. In Quick Memory mode, it shows the Quick Memory number location (the Quick Memory number ranges from “0_” to “9_”) {page 55}.

27 日

Displays a communication mode {page 19}.

28 AUTO

Appears when Auto Mode function is ON {page 61}.

29 8.8.8.8.8.8

The transceiver operating frequency display. In Menu mode, it displays the parameters.

30 日

In the normal operating mode, it displays the transceiver status and Menu item descriptions when necessary. While the RIT, XIT or SPLIT function is turned ON, it is used to display the frequency information for these functions {pages 35, 37}.

31 <A>

“<A>” or “A>” appears while VFO A is selected {pages 18, 30}. “A” appears while Menu A is being accessed in the Menu mode {page 22}.

**32 **

“” or “B>” appears while VFO B is selected {pages 18, 30}. “B” appears while Menu B is being accessed in the Menu mode {page 22}.

33 <M>

“<M>” or “M>” appears while a simplex memory channel is selected {page 50}.

34 RIT

Appears when Receive Incremental Tuning function is ON {page 35}.

35 XIT

Appears when Transmit Incremental Tuning function is ON {page 37}.

36 CT

“T” appears when the Tone function is ON {page 32}. “CT” appears when the CTCSS (Continuous Tone Coded Squelch System) is ON {page 33}.

37 PC

Appears when the transceiver is being controlled by a PC {page 67}.

TX/ RX UNIT

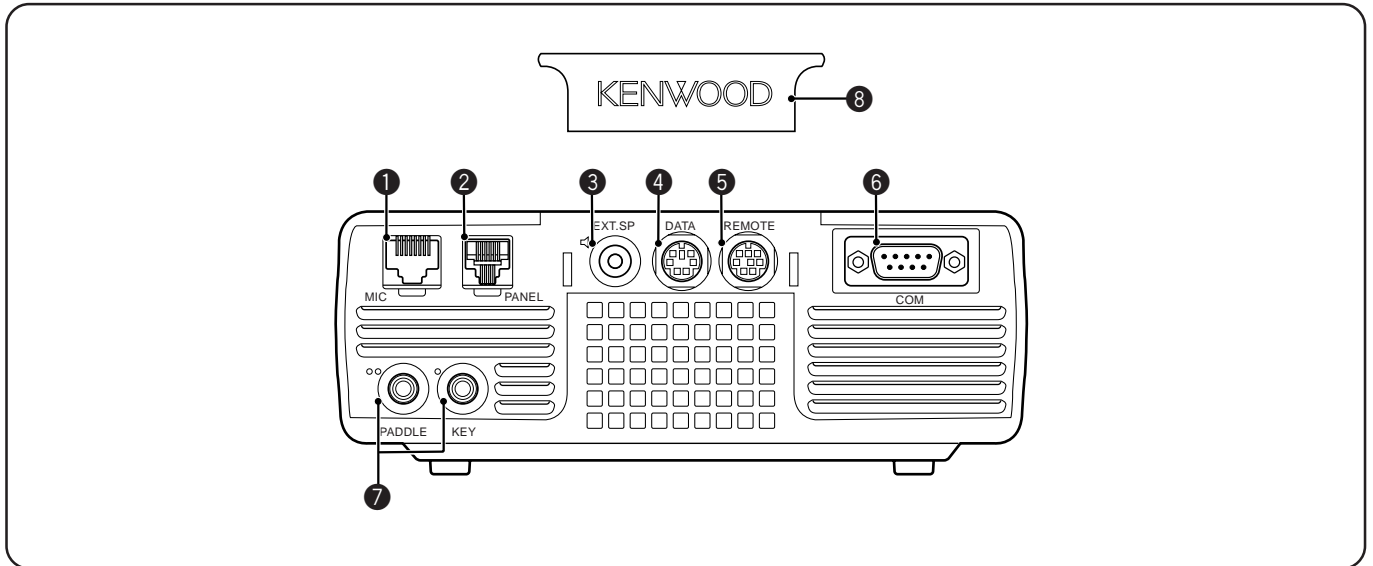
**1 MIC** connector

Connect a cable from the supplied microphone to this connector {page 6}.

2 PANEL connector

Connect a cable from the Remote Control panel to this connector {page 6}.

3 EXT.SP jack

Mate with a 3.5 mm (1/8"), 2-conductor (mono) plug for connecting an external speaker {page 7}.

4 DATA connector

Mates with a 6-pin male DIN connector for connecting various accessory equipment, such as an external TNC/ MCP or a RTTY terminal {pages 77, 78}.

5 REMOTE connector

Mates with a 6-pin male mini DIN connector for connecting an HF/ 50 MHz linear amplifier {page 77}.

6 COM connector

Mates with a DB-9 female connector for connecting a computer via one of its serial communication (COM) ports {page 67}. Also used with the Quick Data Transfer function {pages 66, 76} and DX PacketCluster Tune function {pages 72, 79}.

7 PADDLE and **KEY** jacks

The PADDLE jack mates with a 6.3 mm (1/4") 3-conductor plug for connecting a keyer paddle to the internal electronic keyer. The KEY jack mates with a 3.5 mm (1/8") 2-conductor plug for connecting an external key for CW operation. Refer to "Keys for CW (PANEL and KEY)" {page 7} before using these jacks.

8 Plastic cover

If the **EXT.SP** jack, **DATA** connector and **REMOTE** connector are not used, attach this cover to protect the connectors from dust.

3 GETTING ACQUAINTED

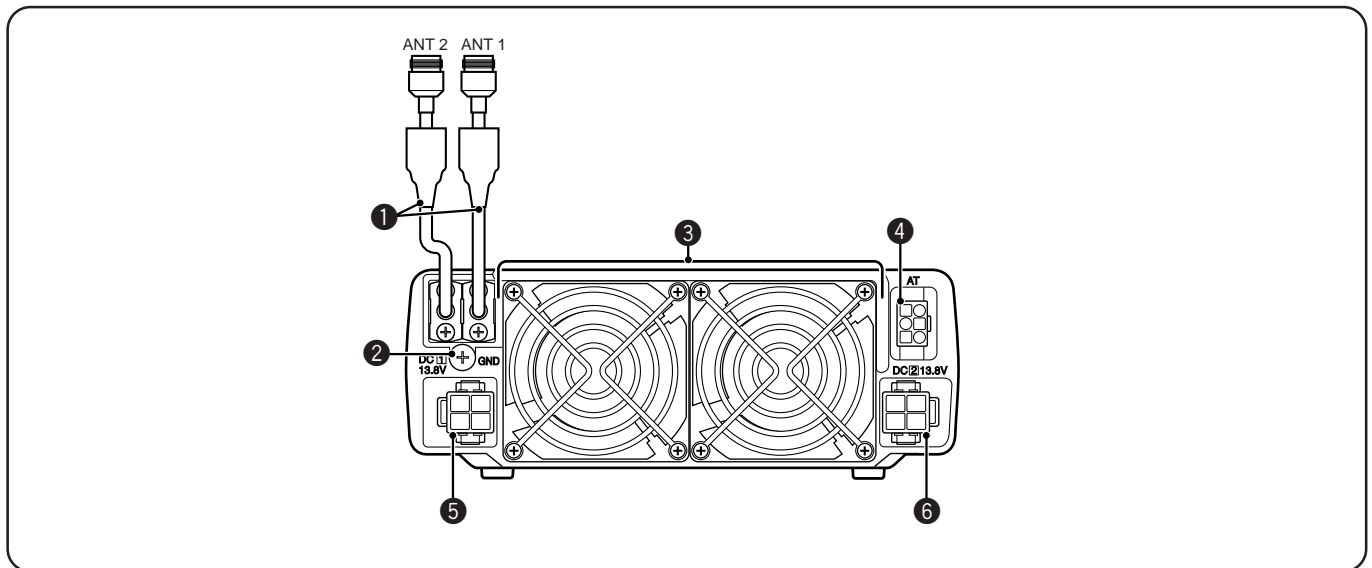

❶ ANT 1 and ANT 2 connectors

Connect your primary HF/ 50 MHz antenna to ANT 1 connector. If you are using 2 antennas for the HF/ 50 MHz band, connect the secondary antenna to the ANT 2 connector.

❷ GND post

Connect a heavy gauge wire or copper strap between the ground post and the nearest earth ground or vehicle body {pages 2, 4}.

❸ Cooling Fans

The TS-480SAT is equipped with 1 cooling fan.
The TS-480HX is equipped with 2 cooling fans.
Air flows in from these fans.

❹ AT connector

Mates with the connector from the cable supplied with the AT-300 external antenna tuner. Refer to the instruction manual supplied with the tuner for more information.

❺ DC 1 13.8 V DC power input connector

Connect a primary 13.8 V DC power source to this connector {pages 2, 3}. Use the DC cable supplied with the transceiver.

❻ DC 2 13.8 V DC power input connector (TS-480HX only)

You must connect a secondary 13.8 V DC power source to this connector in order to transmit {pages 2, 3}. Use the cable supplied with the transceiver. If no DC power source is available on this connector, you cannot transmit at any output power. However, you can still receive {page 18}.

REMOTE CONTROL PANEL (REAR)

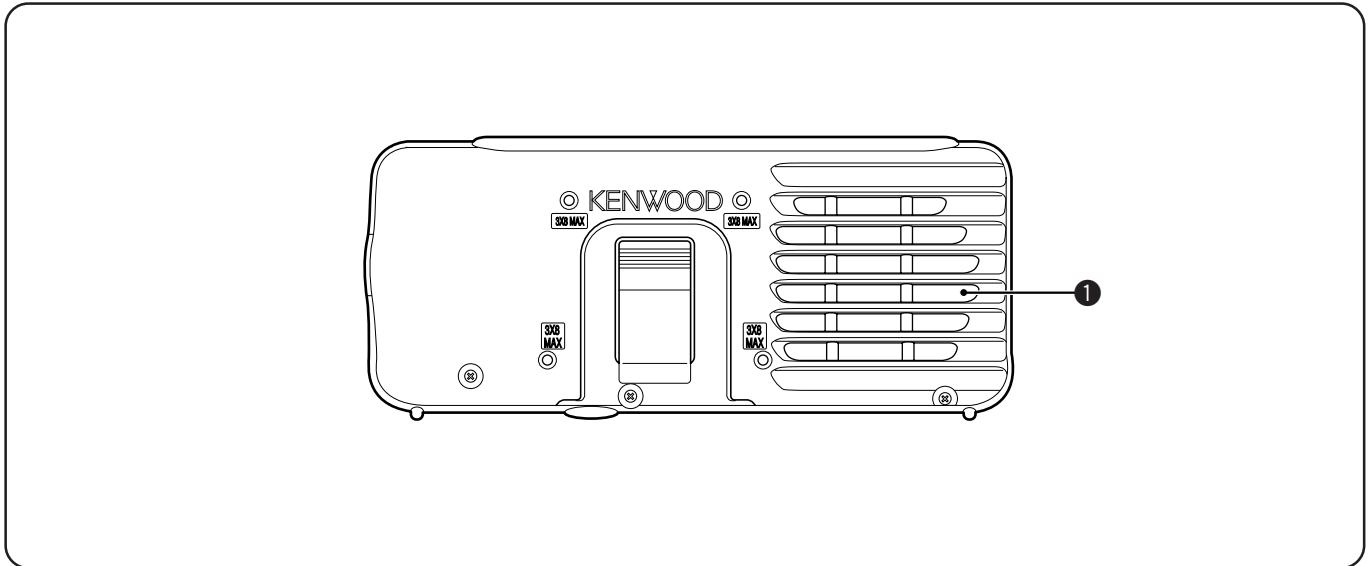

- 1 Speaker**
When the headphones are connected, the speaker mutes.

If you wish to use a commercially available 3rd party angle or mount, there are 4 screw holes available on the rear of the Remote Control panel so that you can mount it to the angle or mount. Use 3 mm x 8 mm tapping screws to mount the panel securely to the angle or mount. (The tapping screws are not supplied).

MICROPHONE

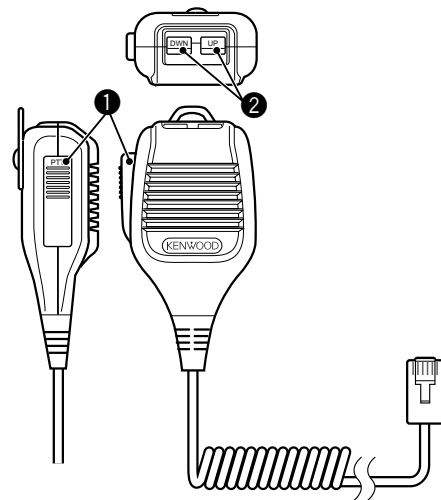

- 1 PTT (Push-to-Talk) switch**

The transceiver is placed in Transmission mode when this non-locking switch is held down. Releasing the switch returns the transceiver to Reception mode.

- 2 UP/ DWN keys**

Use these keys to step the VFO frequency, Memory Channels, or Menu selections up and down. Press and hold these keys to continuously change the settings.

OPERATING BASICS

SWITCHING POWER ON/ OFF

- 1 Switch the DC power supply(s) ON if you are using a DC power supply(s).
- 2 Press and hold [] (POWER) briefly to switch the transceiver ON.

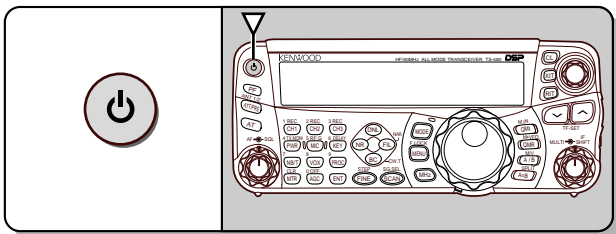

- Do not press the switch for more than approximately 2 seconds; the transceiver will be switched OFF.
 - **TS-480HX only:** If “RX ONLY” appears on the sub-display upon power up, confirm that two DC cable connectors are securely connected to the DC-1 and DC-2 connectors. When this warning message appears, you can receive signals as usual but you cannot transmit even if you decrease the output power. “TWIN PWR” appears when two DC power cables are connected to the DC-1 and DC-2 connectors.
 - Upon power up, “HELLO” appears on the main display, followed by the selected frequency and other indicators.
- 3 To switch the transceiver OFF, press [] (POWER) again.
 - 4 Switch the DC power supply(s) OFF.
 - You may skip step 3. After switching the transceiver ON, you can switch it OFF or ON using only the power switch of the DC power supply(s). The transceiver remembers the information of the POWER switch position when the DC power source is switched OFF.

ADJUSTING VOLUME

AF (AUDIO FREQUENCY) GAIN

Turn the **AF** control clockwise to increase the audio level and counterclockwise to decrease the level.

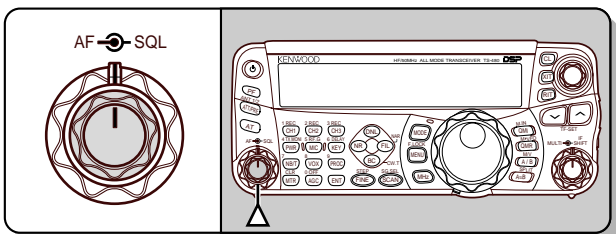

Note: The position of the **AF** control does not affect the volume of beeps caused by pressing keys nor the CW TX sidetone. The audio level for Digital mode operation is also independent of the **AF** control setting.

RF (RADIO FREQUENCY) GAIN

The RF gain is normally configured to the maximum level regardless of the operating modes. The transceiver has been configured to the maximum level at the factory. However, you may decrease the RF gain slightly when you have trouble hearing the desired signal because of excessive atmospheric noise or interference from other stations. First, take note of the peak S-meter reading of the desired signal.

- 1 Press [**MIC/ RF.G**] (1 s).

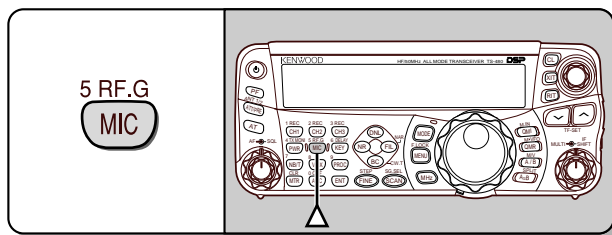

- The current RF gain level appears on the sub-display (0: minimum ~ 100: maximum).
- 2 Turn the **MULTI** control counterclockwise until the S-meter reads the peak value that you noted.

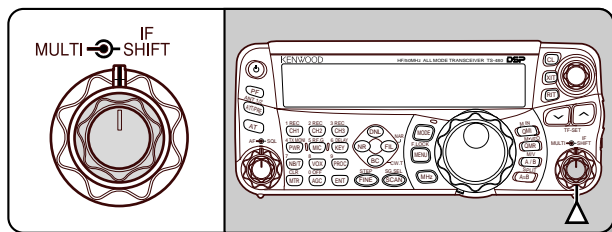

- Signals that are weaker than this level will be attenuated and reception of the station will become easier.

Depending on the type and gain of your antenna, and the condition of the band, adjust the RF gain. When using FM mode, always adjust the RF gain to the maximum level.

SELECTING VFO A OR VFO B

Two VFOs are available for controlling the frequency on the transceiver. Each VFO (VFO A and VFO B) works independently so that a different frequency and mode can be selected. For example, when SPLIT operation is activated, VFO A is used for reception and VFO B is used for transmission. The opposite combination is also possible.

Press [**A/B / M/V**] to toggle between VFO A and B.

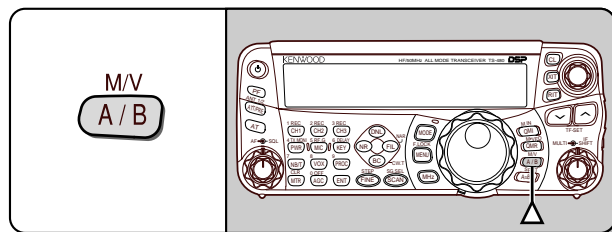

- “◀A” or “◀B” appears to indicate which VFO is selected.

SELECTING A BAND

Press [V]/ [^] to select your desired band.

- Holding down either key changes the bands continuously.

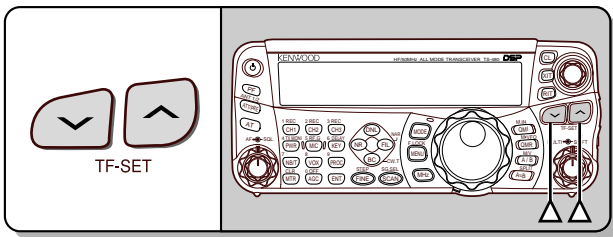

SELECTING A MODE

Press [MODE] to cycle through the 4 mode pairs: USB/ LSB, CW/ CWR, FSK/ FSR, and AM/ FM. Each time you press [MODE], the mode display cycles USB or LSB, CW or CWR, FSK or FSR, FM or AM. To select the other mode on each pair, press [MODE] (1 s). For example, to select “LSB” while “USB” is visible, press [MODE] (1 s). “USB” changes to “LSB”. Press [MODE] (1 s) again to go back to “LSB” from “USB”. The following illustration describes how to access each mode with the [MODE] key.

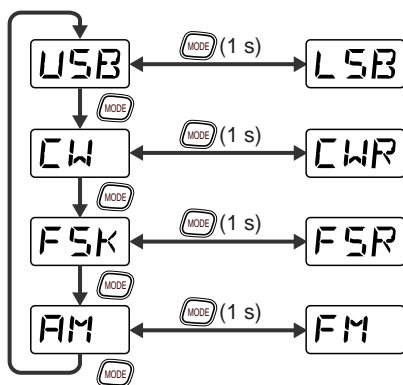
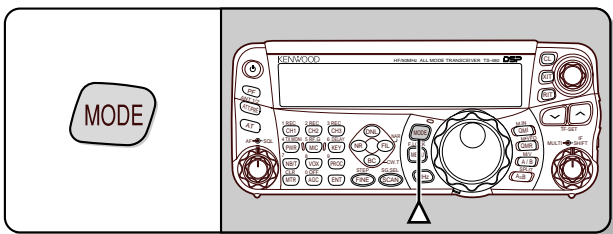

Access Menu No. 02 then press [^] to select “on” to turn the Auto Mode selection ON. When it is ON, “AUTO” appears. As a default setting, if you change the frequency above or below 9.5 MHz, the transceiver automatically switches modes; LSB for frequencies under 9.5 MHz and USB for frequencies equal to or over 9.5 MHz. You can further add the frequency table data to change the mode automatically {page 61}.

ADJUSTING SQUELCH

The purpose of the Squelch is to mute the speaker when no signals are present. With the squelch level correctly set, you will hear sound only while actually receiving signals. The higher the selected squelch level, the stronger the signals must be to receive. The appropriate squelch level depends on the ambient RF noise conditions.

Turn the **SQL** control when there are no signals present to select the squelch level at which the background noise is just eliminated; the green LED will turn off. Many ham operators prefer leaving the **SQL** control fully counterclockwise unless operating on a full-carrier mode such as FM. The squelch level for the main transceiver is preset at the factory to approximately the 9 o'clock position for FM and 11 o'clock for SSB and AM.

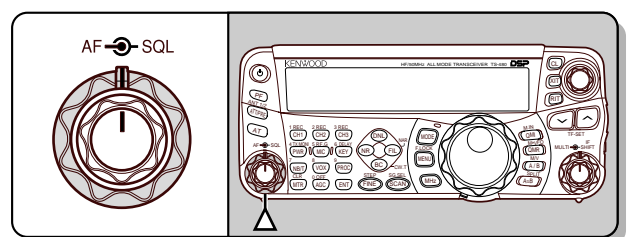

SELECTING A FREQUENCY

Turn the **Tuning** control clockwise or press Mic [UP] to increase the frequency. Turn the **Tuning** control counterclockwise or press Mic [DWN] to decrease the frequency.

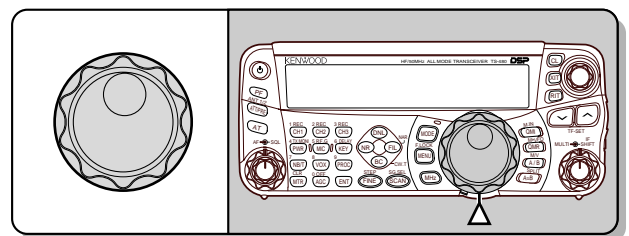

You may prefer directly entering a frequency using the numeric keypad if the desired frequency is far from the current frequency. Press [ENT], then press the numeric keys as necessary. For details, refer to “Direct Frequency Entry” {page 34}.

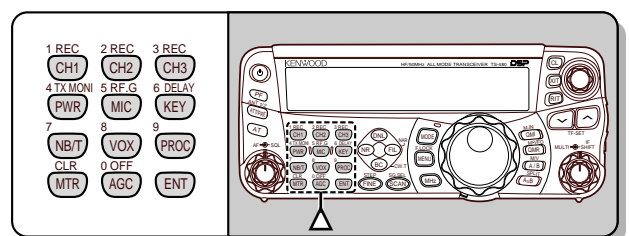

This transceiver provides many other methods for quickly selecting a frequency. For further information, refer to “SELECTING YOUR FREQUENCY” {page 34}.

4 OPERATING BASICS

MULTI-FUNCTION METER

The multi-function meter measures the parameters in the table below. The S-meter scale appears when the transceiver is in reception mode, and the PWR meter appears when it is in transmission mode. Each time you press **[MTR/ CLR]**, it cycles between the ALC, SWR, and COMP meters. Peak readings for the S-meter, ALC, SWR, COMP, and PWR functions are held momentarily.

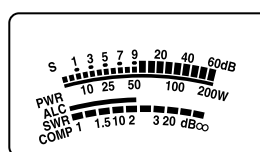
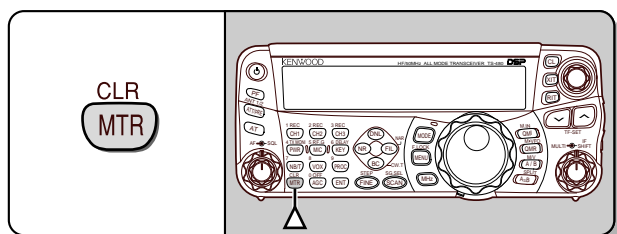

Multi-function meter

Meter	What Is Measured?
S	Strength of received signals
PWR	Transmission output power
ALC	Automatic level control status
SWR	Antenna system standing wave ratio
COMP	Speech compression level when using the Speech Processor {page 37}

Note:

- ◆ The COMP meter functions only when the Speech Processor is ON for SSB, FM, or AM mode.
- ◆ Peak Hold readings cannot be deactivated.
- ◆ The S-meter responds differently in FM mode, compared to other modes. This is not a malfunction.

TRANSMITTING

For voice communications, press and hold Mic **[PTT]**, then speak into the microphone in your normal tone of voice. When you finish speaking, release Mic **[PTT]** to receive.

To transmit CW, press **[VOX/ 8]** to switch the Break-in function ON. "VOX" appears. Close the key or keyer paddle. Connect a key or keyer paddle {pages 7, 15}, then select CW using **[MODE]** {page 19}.

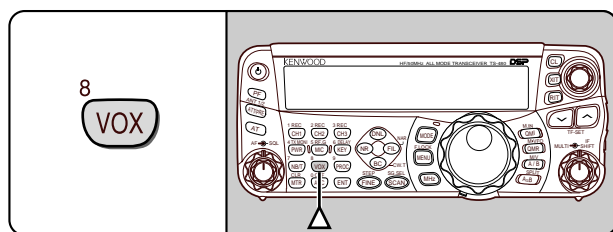

For a detailed explanation on transmitting, refer to "BASIC COMMUNICATIONS", beginning on page 27.

SELECTING TRANSMISSION POWER

It is wise to select a lower transmission power if communication is still reliable. This lowers the risk of interfering with others on the band. When operating from battery power, selecting a lower transmission power allows you more operating time before recharging is necessary. This transceiver allows you to change the transmission power even while transmitting.

- 1 Press **[PWR/ 4/ TX MONI]**.
 - The current transmission power appears.

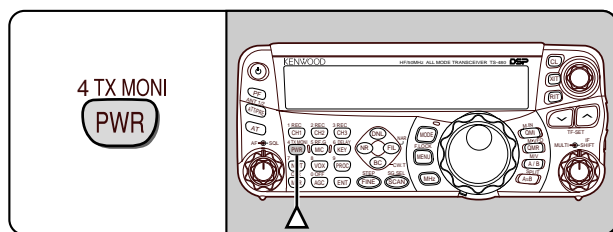

- 2 Turn the **MULTI** control counterclockwise to reduce the power or clockwise to increase the power.

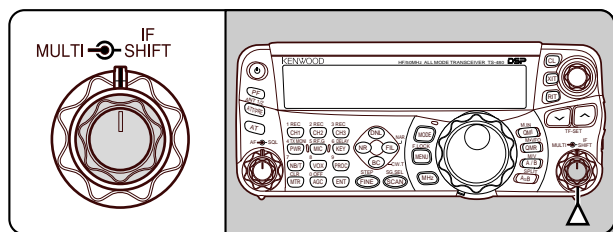

- The selectable range differs, depending on the transceiver model, the current band, and the mode.

- 3 Press **[PWR/ 4/ TX MONI]** to complete the setting.

Note: You may access Menu No. 21, and select "on" to change the step size from 5 W to 1 W {page 65}.

MICROPHONE GAIN

The microphone gain must be adjusted when SSB or AM mode is selected without using the speech processor {pages 27, 28}.

1 Press [MIC/ 5/ RF.G].

- The current microphone gain level appears. The range is from 0 to 100 with a default of 50.

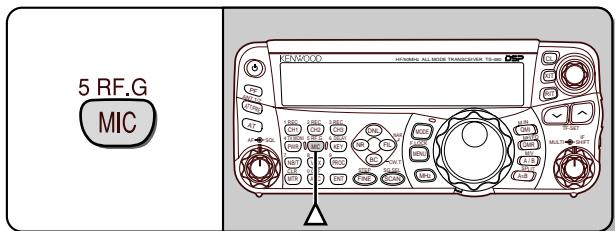

2 Press and hold Mic [PTT].

- The LED on the panel lights red.

3 SSB: While speaking into the microphone, adjust the **MULTI** control so that the ALC meter reflects your voice level but does not exceed the ALC limit.

AM: While speaking into the microphone, adjust the **MULTI** control so that the power meter slightly reflects your voice level.

FM: Access Menu No. 44 and select "1" (Normal), "2" (Medium), or "3" (High) for the microphone gain if necessary {page 27}.

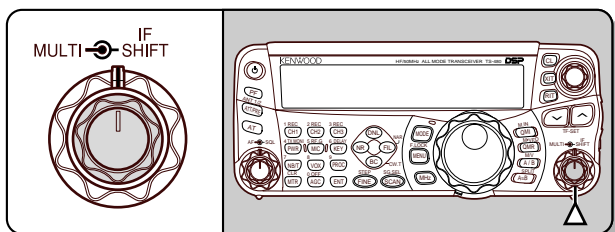

4 Release Mic [PTT] to return to receive.

- The LED lights green or turns off, depending on the **SQL** control setting.

Note: When using the MC-90 microphone with the MJ-88 in FM mode, select "3" (High) for the microphone gain. The microphone sensitivity is low in FM mode. This may cause insufficient modulation. For other microphones, select either "1" (Normal) or "2" (Medium).

MENU SETUP

WHAT IS A MENU?

Many functions on this transceiver are selected or configured via a software-controlled Menu, rather than through the physical controls of the transceiver. Once familiar with the Menu system, you will appreciate the versatility it offers. You can customize the various timings, settings, and programming functions on this transceiver to meet your needs without using many controls and switches.

MENU A/ MENU B

This transceiver has 2 menus: Menu A and Menu B. These menus contain identical functions and can be configured independently. The transceiver, therefore, allows you to switch between 2 different environments quickly and easily. For example, you can configure Menu A for DXing and contesting while Menu B is for relaxed local ragchewing. By switching from Menu A to Menu B, you can instantly change the Menu configuration and key assignment to suit your current operating style. Or, 2 operators may share a single transceiver by dedicating one Menu to each operator. Both operators can always enjoy their own configuration.

MENU ACCESS

- 1 Press **[MENU/ F.LOCK]**.
 - The Menu No. and setting appear on the display, and the explanation of the menu appears on the sub-display.

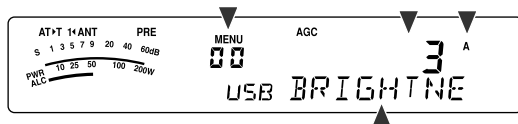

- 2 Press **[A/B / M/V]** to select Menu A or Menu B.
 - "A" or "B" appears, indicating which Menu is selected.
- 3 Turn the **MULTI** control to select the desired Menu No.
 - Each time you change the Menu No., a different scrolling message appears on the sub-display, describing the Menu No.
- 4 Press **[v]/ [^]**, or Mic **[UP]/ [DWN]** to select a parameter.

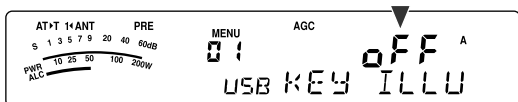

- 5 Press **[MENU/ F.LOCK]** to exit Menu mode.

QUICK MENU

Because the number of functions this transceiver provides is extraordinary, there are numerous items in each Menu. If you find accessing desired Menu Nos. to be too time consuming, use the Quick Menu to create your own customized, abbreviated Menu. You can then add those Menu Nos. which you frequently use, to the Quick Menu. Copying Menu Nos. to the Quick Menu has no effect on the Menu.

PROGRAMMING THE QUICK MENU

- 1 Press **[MENU/ F.LOCK]**.
- 2 Turn the **MULTI** control to select the desired Menu No.
- 3 Press **[QMI/ M.IN]**.
 - An inverted star, "☐" appears, indicating that the Menu item has been added to the Quick Menu.
- 4 Press **[MENU/ F.LOCK]** to exit Menu mode.

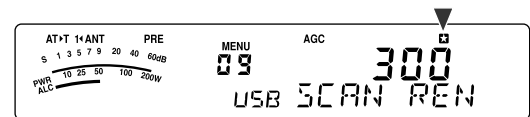

- To remove the item from the Quick Menu, press **[QMI/ M.IN]** again. "☐" disappears.
- 4 Press **[MENU/ F.LOCK]** to exit Menu mode.

USING THE QUICK MENU

- 1 Press **[MENU/ F.LOCK]**.
- 2 Press **[MHz]**.
 - "MHz" appears.
- 3 Turn the **MULTI** control to select the desired Quick Menu No.
- 4 Press **[v]/ [^]**, or Mic **[UP]/ [DWN]** to change the current setting for the selected Menu No.
 - When the Menu is registered to the Quick Menu list, "☐" appears.
- 5 Press **[MENU/ F.LOCK]** to exit Quick Menu mode.

Note: If the Quick Menu has not been programmed, turning the **MULTI** control in step 2 causes "CHECK" to be output in Morse code.

MENU CONFIGURATION

Group	Menu No.	Function	Selections	Default	Ref. Page
Operator Interface	00	Display brightness OFF, 1: minimum, 4: maximum	oFF/ 1 to 4	3	63
	01	Key illumination	oFF/ on	on	63
Tuning Control	02	Auto Mode operation	oFF/ on	oFF	61
	03	Tuning control adjustment rate	250/ 500/ 1000	500	35
	04	Tuning with Tuning control in FM mode	oFF/ on	oFF	34
	05	Rounds off VFO frequencies changed by using the MULTI control	oFF/ on	on	34
	06	9 kHz frequency step size for the MULTI control in AM mode on the AM broadcast band	oFF/ on	See Reference Page	34
Memory Channel	07	Tunable (ON) or fixed (OFF) memory channel frequencies	oFF/ on	oFF	52
Scan Operation	08	Program scan partially slowed	oFF/ on	on	57
	09	Slow down frequency range for the Program scan	100/ 200/ 300/ 400/ 500 Hz	300	57
	10	Program scan hold	oFF/ on	oFF	57
	11	Scan resume method	to (Time-Operated)/ co (Carrier-Operated)	to	58
Monitor Sound	12	Beep output level OFF, 1: minimum, 9: maximum	oFF/ 1 to 9	4	62
	13	TX sidetone volume OFF, 1: minimum, 9: maximum	oFF/ 1 to 9	5	29
	14	VGS-1 message playback volume OFF, 1: minimum, 9: maximum	oFF/ 1 to 9	4	69
	15	VGS-1 announcement volume OFF, 1: minimum, 7: maximum	oFF/ 1 to 7	4	71
	16	VGS-1 announcement speed 0: slow, 4: fast	0 to 4	1	71
IF Filter	17	Use CW IF filter for SSB reception	oFF/ on	oFF	45
DSP Equalizer	18	DSP RX equalizer oFF: Flat Hb1: High boost 1 Hb2: High boost 2 FP: Formant pass bb1 Bass boost 1 bb2: Bass boost 2 c: Conventional U: Flat (Reserved for ARCP software)	oFF/ Hb1/ Hb2/ FP/ bb1/ bb2/ c/ U	oFF	64

5 MENU SETUP

Group	Menu No.	Function	Selections	Default	Ref. Page
DSP Equalizer	19	DSP TX equalizer oFF: Flat Hb1: High boost 1 Hb2: Hight boost 2 FP: Formant pass bb1: Bass boost 1 bb2: Bass boost 2 c: Conventional U: Flat (Reserved for ARCP software)	oFF/ Hb1/ Hb2/ FP/ bb1/ bb2/ c/ U	oFF	38
TX Filter	20	DSP TX filter bandwidth for SSB or AM	2.0/ 2.4 kHz	2.4	38
TX Power	21	Fine transmission power tuning	oFF/ on	oFF	65
TOT	22	Time-out timer	oFF/ 3/ 5/ 10/ 20/ 30 minutes	oFF	65
Transverter	23	Transverter frequency display	oFF/ on	oFF	65
	24	Output power adjustment for Transverter	oFF/ on	on	65
Antenna Tuner	25	TX hold when AT completes the tuning	oFF/ on	oFF	60
	26	In-line AT while receiving	oFF/ on	oFF	60
	27	Control method for the external AT	At1/ At2	At1	61
Linear Amplifier	28	Linear amplifier control delay for HF band	oFF/ 1/ 2/ 3	oFF	63
	29	Linear amplifier control delay for 50 MHz band	oFF/ 1/ 2/ 3	oFF	63
Message Playback	30	Constant recording	oFF/ on	oFF	69
	31	Repeat the playback	oFF/ on	oFF	41, 69
	32	Interval time for repeating the playback	0 to 60 seconds (in steps of 1 second)	10	41, 69
CW	33	Keying priority over playback	oFF/ on	oFF	41
	34	CW RX pitch/ TX sidetone frequency	400 to 1000 Hz (in steps of 50 Hz)	800	29
	35	CW keying dot, dash weight ratio	AUto/ 2.5 to 4.0 (in steps of 0.1)	AUto	39
	36	Reverse CW keying auto weight ratio	oFF/ on	oFF	39
	37	Bug key function	oFF/ on	oFF	40
	38	Swap dot and dash paddle position	oFF/ on	oFF	41
	39	Auto CW TX in SSB mode	oFF/ on	oFF	41
	40	Frequency correction for changing SSB to CW	oFF/ on	oFF	41
FSK	41	FSK shift	170/ 200/ 425/ 850 Hz	170	42
	42	FSK keying polarity	oFF (Normal)/ on (Reverse)	oFF	42, 77
	43	FSK tone frequency	1275/ 2125 Hz	2125	42, 77
FM	44	Mic gain for FM	1 (Normal)/ 2 (Medium)/ 3 (High)	1	27

Group	Menu No.	Function	Selections	Default	Ref. Page
Data Comm.	45	Filter bandwidth for Data communications	oFF/ on	oFF	48
	46	AF input level for Data communications (0: minimum ~ 9: maximum)	0 to 9	4	77, 78
	47	AF output level for Data communications (0: minimum ~ 9: maximum)	0 to 9	4	77, 78
PF keys	48	Remote Control panel PF key	00 to 93 and 99	61 (VOICE1)	64
	49	Microphone PF1 key	00 to 93 and 99	75 (A/B)	64
	50	Microphone PF2 key	00 to 93 and 99	74 (SPLIT)	64
	51	Microphone PF3 key	00 to 93 and 99	76 (M/V)	64
	52	Microphone PF4 key	00 to 93 and 99	63 (RX MONI)	64
Quick Data Transfer	53	Split frequency transfer in master/ slave operation	oFF/ on	oFF	66
	54	Permit to write the transferred Split frequencies to the target VFOs	oFF/ on	oFF	66
TX Inhibit	55	TX inhibit	oFF/ on	oFF	38
COM port	56	COM port communication speed	4800/ 9600/ 19200/ 38400/ 57600/ 115200 bps	9600	67
Crossband Repeater	57	DTS polarity	oFF/ on	oFF	71, 79
Busy Lockout	58	Busy lockout (TX)	oFF/ on	oFF	38
APO	59	APO (Auto Power Off) function	oFF/ 60/ 120/ 180 minutes	oFF	60
VOX Source	60	Transmit with the audio input on the DATA terminal	oFF/ on	oFF	36

5 MENU SETUP

ALPHABETICAL FUNCTION LIST

Function	Menu No.
9 kHz frequency step size for the MULTI control in AM mode on the AM broadcast band	06
AF input level for Data communications	46
AF output level for Data communications	47
APO (Auto Power Off) function	59
Auto CW TX in SSB mode	39
Auto Mode operation	02
Beep output level	12
Bug key function	37
Busy lockout (TX)	58
COM port communication speed	56
Constant recording	30
Control method for the external AT	27
CW keying dot, dash weight ratio	35
CW RX pitch/ TX sidetone frequency	34
Display brightness	00
DSP RX equalizer	18
DSP TX equalizer	19
DSP TX filter bandwidth for SSB or AM	20
DTS polarity	57
Filter bandwidth for Data communications	45
Fine transmission power tuning	21
Frequency correction for changing SSB to CW	40
Remote Control panel PF key	48
FSK keying polarity	42
FSK shift	41
FSK tone frequency	43
In-line AT while receiving	26
Interval time for repeating the playback	32
Key illumination	01
Keying priority over playback	33
Linear amplifier control delay for HF band	28
Linear amplifier control delay for 50 MHz band	29
Mic gain for FM	44
Microphone PF1 key	49
Microphone PF2 key	50
Microphone PF3 key	51
Microphone PF4 key	52
Output power adjustment for Transverter	24
Permit to write the transferred Split frequencies to the target VFOs	54
Program scan hold	10
Program scan partially slowed	08

Function	Menu No.
Reverse CW keying auto weight ratio	36
Repeat the playback	31
Round off VFO frequencies changed by using the MULTI control	05
Scan resume method	11
Slow down frequency range for the Program scan	09
Split frequency transfer in master/ slave operation	53
Swap dot and dash paddle position	38
Time-out timer	22
Transmits with the audio input on the DATA terminal	60
Transverter frequency display	23
Tunable (ON) or fixed (OFF) memory channel frequencies	07
Tuning control adjustment rate	03
Tuning with Tuning control in FM mode	04
TX hold when AT completes the tuning	25
TX inhibit	55
TX sidetone volume	13
Use CW IF filter for SSB reception	17
VGS-1 announcement speed	16
VGS-1 announcement volume	15
VGS-1 message playback volume	14

SSB TRANSMISSION

SSB is the most commonly-used mode on the HF Amateur radio bands. Compared with other voice modes, SSB requires only a narrow bandwidth for communications. SSB also allows long distance communications with minimum transmission power.

If necessary, refer to “OPERATING BASICS”, beginning on page 18, for details on how to receive.

- 1 Select an operating frequency.
- 2 Press **[MODE]** until “USB” or “LSB” appears on the operating mode display.
 - If the desired sideband (“USB” or “LSB”) does not appear, select the other sideband first. Then, press **[MODE] (1 s)**. The mode indicator changes to your desired sideband.
 - “USB” represents the upper sideband and “LSB” represents the lower sideband. Normally, USB is used for the communications for 10 MHz and above. While LSB is used for the frequencies below 10 MHz.



- 3 Press **[MIC/ 5/ RF.G]** to adjust the Microphone gain.
 - The current gain level appears on the sub-display.

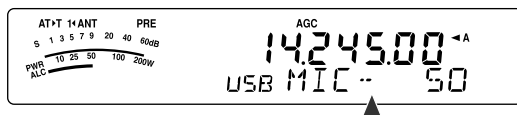

- 4 Press and hold Mic **[PTT]**.
 - The LED above the **[MODE]** key lights red.
 - Refer to “VOX” {page 36} for information on automatic TX/ RX switching.
- 5 Speak into the microphone and turn the **MULTI** control so that the ALC meter reflects your voice level but does not exceed the ALC limit.
 - Speak in your normal tone and level of voice. Speaking too close to the microphone or too loudly may increase distortion and reduce intelligibility at the receiving end.
 - You may want to use the Speech Processor. Refer to “SPEECH PROCESSOR” {page 37} for details.
- 6 Release Mic **[PTT]** to return to Reception mode.
 - The LED lights green or turns off, depending on the **SQL** control position.
- 7 Press **[MTR/ CLR]** or **[MIC/ 5/ RF.G]** to exit the Microphone gain adjustment.

Refer to “COMMUNICATING AIDS”, beginning on page 34, for information on additional useful operation functions.

FM TRANSMISSION

FM is a common mode for communicating on VHF or UHF frequencies. As for HF and the 6 m band, 29 MHz and 51-54 MHz bands are commonly used for FM operation. You can also utilize 10 m/ 6 m band repeaters to reach your friends when they are outside or skipped over from your coverage. Although FM requires a wider bandwidth when compared to SSB or AM mode, it has the finest audio quality among these modes. When combined with the full-quieting aspect of FM signals, which suppress background noise on the frequency, FM can be the best method for maintaining casual communications with your local friends.

If necessary, refer to “OPERATING BASICS”, beginning on page 18, for details on how to receive.

- 1 Select an operating frequency.
- 2 Press **[MODE]** until “FM” appears.
 - If “FM” does not appear, select “AM”, then press **[MODE] (1 s)**. The mode indicator changes to “FM”.



- 3 Press and hold Mic **[PTT]**.
 - The LED lights red.
 - Refer to “VOX” for information on automatic TX/ RX switching {page 36}.
- 4 Speak into the microphone in your normal tone and level of voice.
 - Speaking too close to the microphone or too loudly may increase distortion and reduce intelligibility at the receiving end.
 - You can switch the Microphone gain for FM between 1 (Normal), 2 (Medium), and 3 (High) by using Menu No. 44. 1 (Normal) is usually appropriate; however, select 3 (High) if other stations report that your modulation is weak.
- 5 Release Mic **[PTT]** to return to Reception mode.
 - The LED lights green or turns off, depending on the **SQL** control position.

Refer to “COMMUNICATING AIDS”, beginning on page 34, for additional information on useful operation functions.

Note: Microphone gain adjustment for SSB or AM has no effect in FM mode. In FM mode, you must select 1 (Normal), 2 (Medium), or 3 (High) in Menu No. 44.

AM TRANSMISSION

Each mode used on the HF Amateur bands has its own advantages. Although long distance DX contacts may be less common while using AM, the superior audio quality characteristic of AM operation is one reason why some hams prefer this mode.

When looking for others operating on AM, check the following frequencies first:

3885 kHz, 7290 kHz, 14286 kHz, 21390 kHz, and 29000 ~ 29200 kHz

If necessary, refer to “OPERATING BASICS”, beginning on page 18, for details on how to receive.

- 1 Select an operating frequency.
- 2 Press **[MODE]** until “AM” appears.
 - If “AM” does not appear, select “FM” first, then press **[MODE]** (1 s). The mode indicator changes to “AM”.

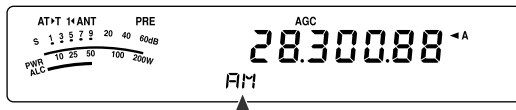

- 3 Press **[MIC/ 5/ RF.G]** to enter the Microphone gain adjustment mode.
 - The current gain level appears on the sub-display.
- 4 Press and hold Mic **[PTT]**.
 - The LED lights red.
 - Refer to VOX function for information on automatic TX/ RX switching {page 36}.
- 5 Speak into the microphone and adjust the **MULTI** control so that the power meter slightly reflects your voice level.
 - Speak in your normal tone and level of voice. Speaking too close to the microphone or too loudly may increase distortion and reduce intelligibility at the receiving end.
 - You may want to use the Speech Processor. Refer to “SPEECH PROCESSOR” {page 37} for details.
- 6 Release Mic **[PTT]** to return to Reception mode.
 - The LED lights green or turns off, depending on the **SQL** control position.
- 7 Press **[MIC/ 5/ RF.G]** to exit the Microphone gain adjustment mode.

Refer to “COMMUNICATING AIDS”, beginning on page 34, for information on additional useful operation functions.

Note: When the TX power meter reading exceeds the value that you specified in TX Power setting {page 65}, decrease the microphone gain or adjust your tone and level of voice.

NARROW BANDWIDTH FOR FM

Select wide band or narrow band TX deviation depending on whether the other station is using wide band or narrow band filter for FM mode. While “NAR” appears, the TS-480 transceiver transmits signals in narrow band FM but the reception IF filter bandwidth remains unchanged (Wide). The deviation selection is crucial to avoid audio distortion or insufficient intelligibility that the other station will encounter.

- 1 Press **[MODE]** until “FM” appears.
 - If “FM” does not appear, select “AM” first, then press **[MODE]** (1 s). The mode indicator changes to “FM”.
- 2 Press **[FIL/ NAR]** (1 s) to toggle the selection between wide and narrow TX deviation.
 - “NAR” appears when the narrow TX deviation is selected.

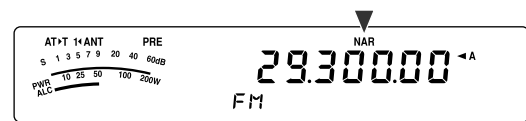

NARROW BANDWIDTH FOR AM

When receiving AM, you can further decrease the bandwidth to eliminate interference. However, the transmission deviation of AM is not affected by this selection.

- 1 Press **[MODE]** until “AM” appears.
 - If “AM” does not appear, select “FM” first, then press **[MODE]** (1 s). The mode indicator changes to “AM”.
- 2 Press **[FIL/ NAR]** (1 s) to toggle the selection between Normal and Narrow.
 - “NAR” appears when the narrow bandwidth is selected for the AM reception.

CW TRANSMISSION

CW operators know that this mode is very reliable when communicating under worst conditions. It may be true that newer digital modes rival CW as being equally as useful in poor conditions. These modes, however, do not have the long history of service nor the simplicity that CW provides.

This transceiver has a built-in electronic keyer that supports a variety of functions. For details on using these functions, refer to “ELECTRONIC KEYS” {page 39}.

If necessary, refer to “OPERATING BASICS”, beginning on page 18, for details on how to receive.

- 1 Select the operating frequency.
- 2 Press **[MODE]** until “CW” or “CWR” appears.

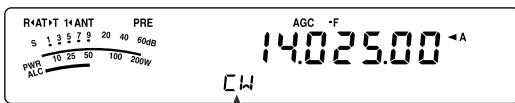

- To precisely tune in another station, use Auto Zero-beat. Refer to “AUTO ZERO-BEAT” {below}.
- 3 Press **[VOX/ 8]** to activate the CW break-in function.
 - “VOX” appears.
 - Refer to “CW BREAK-IN” for further information on automatic TX/ RX switching {page 39}.
 - 4 Begin sending the message.
 - As you transmit, you should hear a sidetone that lets you monitor your own transmission.
 - The LED lights red as you send the message.
 - 5 Stop sending the message to return to Reception mode.
 - The LED lights green or turns off, depending on the **SQL** control setting.

AUTO ZERO-BEAT

Use Auto Zero-beat before transmitting to tune in a CW station. Auto Zero-beat automatically and exactly matches your transmit frequency with the station you are receiving. Neglecting to do this will reduce your chances of being heard by the other station.

- 1 Tune to the CW signal using the **Tuning** control.
- 2 Press **[BC/ CW.T]** (1 s) to start Auto Zero-beat while CW is selected for the operating mode.
 - “CW TUNE” appears.

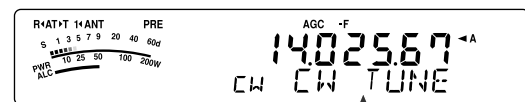

- Your reception frequency automatically changes so that the pitch (tone) of the received signal exactly matches the TX sidetone/ RX pitch frequency that you have selected. Refer to “TX SIDETONE/ RX PITCH FREQUENCY” {below}.
 - When matching is completed, “CW TUNE” disappears.
 - If matching is unsuccessful, the previous frequency is restored.
- 3 To quit Auto Zero-beat, press **[CLR/ MTR]** or press **[BC/ CW.T]** again.

Note:

- ◆ You cannot start Auto Zero-beat if you have selected 1.0 kHz or wider for the DSP filter bandwidth {page 46}.
- ◆ When using Auto Zero-beat, the matching error is within ± 50 Hz in most cases.
- ◆ Auto Zero-beat may fail if the keying speed of the target station is too slow or some interference is present.
- ◆ When the RIT function is ON, only RIT frequencies change to make the Auto Zero-beat adjustment.

TX SIDETONE/ RX PITCH FREQUENCY

As you send CW, you will hear tones from the transceiver speaker. These are called TX (transmission) sidetones. Listening to these tones, you can monitor what you are transmitting. You may also use the tones to ensure that your key contacts are closing, the keyer is functioning, or to practice sending without actually putting a signal on the air.

RX (reception) pitch refers to the frequency of CW that you hear after tuning in a CW station.

On this transceiver, the frequency of the sidetone and RX pitch are equal and selectable. Access Menu No. 34 to select the frequency that is most comfortable for you. The selectable range is from 400 Hz to 1000 Hz in steps of 50 Hz (default is 800 Hz).

To change the volume of the TX sidetone, access Menu No. 13. The selections range from 1 to 9 and OFF (default is 5).

Note: The position of the **AF** control does not affect the volume of the TX sidetone.

SPLIT-FREQUENCY OPERATION

Usually you can communicate with other stations using a single frequency for receiving and transmitting. In this case, you select only one frequency on either VFO A or VFO B. However, there are cases where you must select one frequency for receiving and a different frequency for transmitting. This requires the use of 2 VFOs. This is referred to as “split-frequency operation”. One typical case which requires this type of operation is when you use an FM repeater {page 31}. Another typical case is when you call a rare DX station.

When a rare or desirable DX station is heard, that operator may immediately get many simultaneous responses. Often, such a station is lost under the noise and confusion of many calling stations. If you find that you are suddenly being called by many operators, it is your responsibility to control the situation. You may announce that you will be “listening up 5 (kHz, from your present transmission frequency)”, or “listening down between 5 and 10 (kHz)”.

- 1 Press **[A/B / M/V]** to select VFO A or VFO B to reception frequency.
 - “◀A” or “◀B” appears to show which VFO is selected.
- 2 Select an operating frequency.
 - The frequency selected at this point will be used for transmission.
 - To copy the selected VFO frequency to the other VFO, press **[A=B/ SPLIT]**.
- 3 Press **[A/B / M/V]** to select the other VFO.
- 4 Select an operating frequency.
 - The frequency selected on this VFO will be used for reception.
- 5 Press **[A=B/ SPLIT] (1 s)**.
 - “SPLIT” appears.

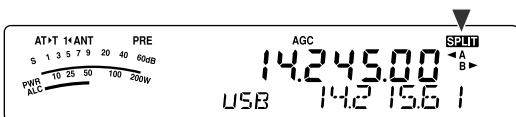

- Each time you press **[A/B / M/V]**, the reception and the transmission frequency are swapped.
- 6 To quit split-frequency operation, press **[A=B/ SPLIT] (1 s)** again.
 - “SPLIT” disappears.

TF-SET (TRANSMISSION FREQUENCY SET)

TF-SET allows you to temporarily switch your transmission frequency and reception frequency. Canceling this function immediately restores the original transmission and reception frequencies. By activating TF-SET, you can listen on your transmission frequency, and change it while listening. This allows you to check whether or not the newly selected transmission frequency is free of interference.

- 1 Configure split-frequency operation as explained in the previous section.
- 2 Press **[MENU/ F.LOCK] (1 s)** to lock the **Tuning** control.
 - “A” appears.

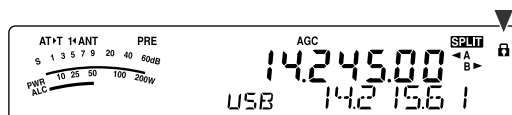

- 3 Press and hold either **[v]** or **[^]** while the “A” icon is visible. While holding down **[v]** or **[^]**, turn the **Tuning** control or press Mic **[UP]/ [DWN]** to change the transmission frequency.

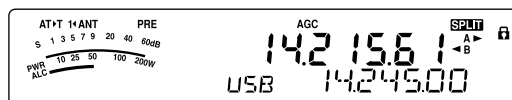

- The transceiver receives on the frequency as you change, but the frequency shown on the sub-display (the original reception frequency) stays unchanged.
- 4 Release **[v]** or **[^]**.
 - You are now receiving again on your original reception frequency.

Successfully contacting a DX station in a pileup often depends on making a well-timed call on a clear frequency. That is, it is important to select a relatively clear transmission frequency and to transmit at the exact instant when the DX station is listening but the majority of the groups aren't transmitting. Switch your reception and transmission frequencies by using the TF-SET function and listen to your transmission frequency. You will soon learn the rhythm of the DX station and the pileup. The more proficient you become at using this function, the more DX stations you will contact.

Note:

- ◆ *TF-SET is disabled while transmitting.*
- ◆ *An RIT offset frequency is not added; however, an XIT offset frequency is added to the transmission frequency.*

FM REPEATER OPERATION

Most Amateur radio voice repeaters use a separate reception and transmission frequency. The transmission frequency may be higher or lower than the reception frequency. In addition, some repeaters may require the transceiver to transmit a subtone before the repeater can be used.

Compared to simplex communication, you can usually transmit over much greater distances by using a repeater. Repeaters are typically located on a mountain top or other elevated location. Often they operate at higher ERP (Effective Radiated Power) than a typical station. This combination of elevation and high ERP allows communications over considerable distances.

HF/ 6 m band repeaters operate usually in the 29 MHz FM sub-band and 51-54 MHz band. This special service combines the advantages of FM operation, good fidelity with noise and interference immunity, with the excitement of HF DX (long distance) communications. Even on a quiet day, 10 m FM provides reliable around-town communications with the potential for sudden DX from across the country or around the world.

Note:

- ◆ When programming 2 separate frequencies using 2 VFOs, be sure to select FM mode on both VFOs.
- ◆ When operating through a repeater, over deviation caused by speaking too loudly into the microphone can cause your signal to "talk-off" (break up) through the repeater.

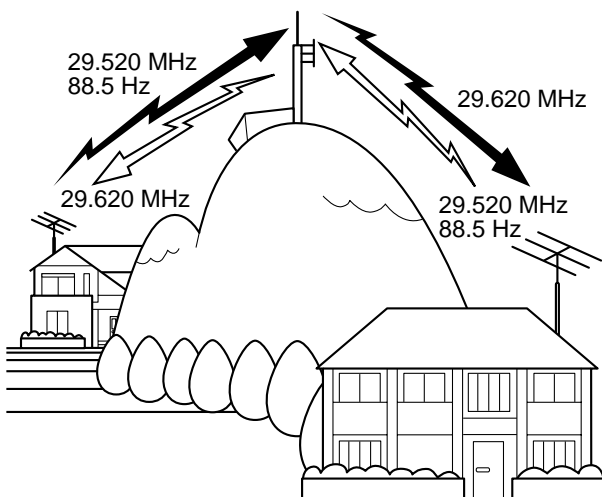

- 1 Press **[A/B / M/V]** to select VFO A or VFO B.
 - “◀A” or “◀B” appears to show which VFO is selected.
- 2 Turn the **Tuning** control or **MULTI** control to select the reception frequency.
- 3 Press **[MODE]** to select FM mode {page 19}.
- 4 Press **[A=B/ SPLIT]** to duplicate the frequencies and other data to the other VFO.
- 5 Turn the **Tuning** control or **MULTI** control to select the transmission frequency.
 - The frequency selected on this VFO will be used for transmission.
- 6 Press **[NB/T/ 7]** to turn the Tone function ON if the repeater requires a subtone.
 - “T” appears.
 - Refer to “Selecting a Tone Frequency” for more details on the subtone {page 32}.



- To quit the Subtone function, press **[NB/T/ 7]** twice.
- 7 Press **[A=B/ SPLIT]** (1 s).
 - “SPLIT” appears.
 - 8 Press **[A/B / M/V]** to go back to the original reception frequency.
 - The VFO changes to the other VFO to transmit.
 - Each time you press **[A/B / M/V]**, the reception and the transmission frequency are swapped.
 - 10 Press **[A=B/ SPLIT]** (1 s) to quit split-frequency operation.
 - “SPLIT” disappears.

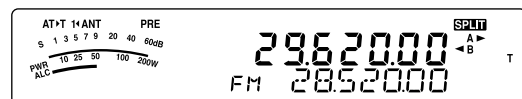

The data that you select in steps 1 to 8 can be stored in memory. Refer to “Split-Frequency Channels” {page 51}.

Note:

- ◆ When operating through a repeater, over deviation caused by speaking too loudly into the microphone can cause your signal to “talk-off” (break up) through the repeater.
- ◆ To check the tone frequency stored in a memory channel, recall the desired memory channel, and press **[NB/T/ 7]** (1 s).

7 ENHANCED COMMUNICATIONS

TRANSMITTING A TONE

In general, FM repeaters require the transceiver to transmit a sub-audible tone to prevent other repeaters on the same frequency from locking each other up. The required tone frequency differs among repeaters. Repeaters also differ in their requirements for either continuous or burst tones. For the appropriate selections for your accessible repeaters, consult your local repeater reference.

After completing the tone settings, pressing and holding Mic **[PTT]** causes the transceiver to transmit the selected tone. If you have selected a 1750 Hz tone, the transceiver sends a 500 ms tone burst each time transmission starts.

Note: If you store tone settings in a memory channel, you need not reprogram each time. Refer to "MEMORY FEATURES" (page 50).

■ Activating the Tone Function

- 1 Confirm that FM mode has been selected on the VFO(s) (page 19).
 - When using 2 VFOs, you must select FM mode on both VFOs.
- 2 Press **[NB/T/ 7]**.
 - "T" appears.



Note: You cannot use the Tone function with the CTCSS function.

■ Selecting a Tone Frequency

- 1 While "T" appears (Tone function is ON), press **[NB/T/ 7]** (1 s).
 - The current tone frequency appears. The default is 88.5 Hz.

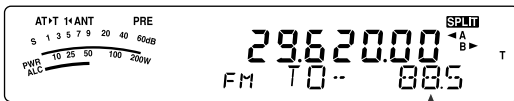

- 2 Turn the **MULTI** control to select the desired tone frequency.
 - The available tone frequencies are listed in the following table.
- 3 Press **[MTR/ CLR]** to complete the setting.

No.	Freq. (Hz)	No.	Freq. (Hz)	No.	Freq. (Hz)	No.	Freq. (Hz)
00	67.0	11	97.4	22	141.3	33	206.5
01	69.3	12	100.0	23	146.2	34	210.7
02	71.9	13	103.5	24	151.4	35	218.1
03	74.4	14	107.2	25	156.7	36	225.7
04	77.0	15	110.9	26	162.2	37	229.1
05	79.7	16	114.8	27	167.9	38	233.6
06	82.5	17	118.8	28	173.8	39	241.8
07	85.4	18	123.0	29	179.9	40	250.3
08	88.5	19	127.3	30	186.2	41	254.1
09	91.5	20	131.8	31	192.8	42	1750
10	94.8	21	136.5	32	203.5		

Note:

- ◆ You can select a tone frequency independent of a CTCSS frequency.
- ◆ When 1750 Hz is selected, the transceiver sends a 500 ms tone burst each time transmission starts. You cannot transmit 1750 Hz tone manually.

TONE FREQ. ID SCAN

This function scans through all tone frequencies to identify the incoming tone frequency on a received signal. You may find this useful when you do not know the tone frequency that the repeater uses.

- 1 While the Tone function is ON ("T" is visible), press **[NB/T/ 7]** (1 s).
 - The current tone frequency appears.
- 2 Press **[SCAN/ SG.SEL]** to activate the Tone frequency ID scan.
 - While the transceiver is receiving a signal, "T" blinks and every tone frequency is scanned. When the tone frequency is identified, the transceiver stops scanning and the identified frequency is displayed.



- Press **[SCAN/ SG.SEL]** to stop scanning while the tone frequency ID scan is active.
- Press **[SCAN/ SG.SEL]** again to resume scanning.

Note: Received signals are audible while scanning is in progress.

FM CTCSS OPERATION

You may sometimes want to hear calls only from specific persons. When using FM mode, the Continuous Tone Coded Squelch System (CTCSS) allows you to ignore (not hear) unwanted calls from other persons who are using the same frequency. A CTCSS tone is sub-audible and is selectable from among the 42 tone frequencies. Select the same CTCSS tone as the other stations in your group. You will not hear calls from stations other than those using the same CTCSS tone.

Note: *CTCSS does not cause your conversation to be private. It only relieves you from listening to unwanted conversations.*

- Press **[A/B / M/V]** to select VFO A or VFO B.
 - “◀A” or “◀B” appears to show which VFO is selected.
- Select the 29 MHz band or the 51-54 MHz band using **[v]** or **[^]**.
- Select the desired frequency with the **Tuning** control or **MULTI** control.
- Press **[MODE]** to select FM mode {page 19}.
- Turn the **SQL** control to adjust the squelch.
- Press **[NB/T/ 7]** until “CT” appears.

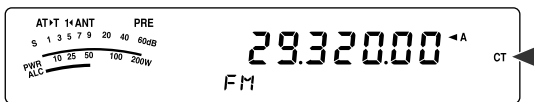

- While “CT” is visible, press **[NB/T/ 7]** (1 s).
 - The current CTCSS frequency appears. The default CTCSS frequency is 88.5 Hz.

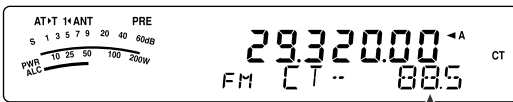

- Turn the **MULTI** control to select the appropriate CTCSS frequency.
 - The selectable CTCSS frequencies are listed in the following table.
- Press **[MTR/ CLR]** to complete the setting.

No.	Freq. (Hz)	No.	Freq. (Hz)	No.	Freq. (Hz)	No.	Freq. (Hz)
00	67.0	11	97.4	22	141.3	33	206.5
01	69.3	12	100.0	23	146.2	34	210.7
02	71.9	13	103.5	24	151.4	35	218.1
03	74.4	14	107.2	25	156.7	36	225.7
04	77.0	15	110.9	26	162.2	37	229.1
05	79.7	16	114.8	27	167.9	38	233.6
06	82.5	17	118.8	28	173.8	39	241.8
07	85.4	18	123.0	29	179.9	40	250.3
08	88.5	19	127.3	30	186.2	41	254.1
09	91.5	20	131.8	31	192.8		
10	94.8	21	136.5	32	203.5		

You will hear calls only when the selected tone is received. To answer the call, press and hold Mic **[PTT]**, then speak into the microphone.

Skip steps **7** and **8** if you have already programmed the appropriate CTCSS frequency.

Note:

- When using split-frequency operation, select FM mode on both VFOs to use CTCSS.
- You can select a CTCSS frequency independent of a tone frequency.
- You cannot use the CTCSS function with the Tone function.

CTCSS FREQ. ID SCAN

This function scans through all CTCSS frequencies to identify the incoming CTCSS frequency on a received signal. You may find this useful when you cannot recall the CTCSS frequency that the other persons in your group are using.

- While the CTCSS function is ON, press **[NB/T/ 7]** (1 s).
 - The current CTCSS frequency appears.
- Press **[SCAN/ SG.SEL]** to activate the CTCSS frequency ID scan.
 - While the transceiver is receiving a signal, “CT” blinks and every CTCSS frequency is scanned. When the CTCSS frequency is identified, the transceiver stops scanning and the identified frequency is displayed.

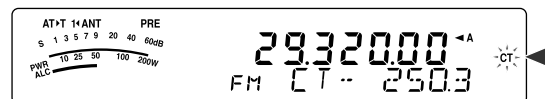

- Press **[SCAN/ SG.SEL]** again to resume scanning.
- Press **[SCAN/ SG.SEL]** to stop scanning while the CTCSS frequency ID scan is active.

Note: *Received signals are audible while scanning is in progress.*

RECEPTION

SELECTING YOUR FREQUENCY

In addition to turning the **Tuning** control or pressing Mic **[UP]**/ **[DWN]**, there are several other ways to select your frequency. This section describes additional methods of frequency selection that may save you time and effort.

■ Direct Frequency Entry

When the desired frequency is far removed from the current frequency, directly entering a frequency from the numeric keypad is usually the fastest method.

1 Press **[ENT]**.

- “- - - - -” appears.

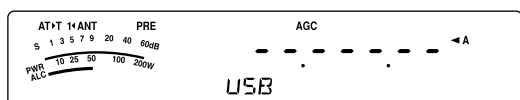

2 Press the numeric keys (**[0]** to **[9]**) to enter your desired frequency.

- Pressing **[ENT]** at any time fills the remaining digits (the digits you did not enter) with 0 and completes the entry. To select 1.85 MHz for example, press **[ENT]**, **[0]**, **[1]**, **[8]**, **[5]**, then press **[ENT]** to complete the input (6 key strokes).
- Pressing **[MTR/ CLR]** before pressing **[ENT]** cancels the entry and restores the current VFO frequency.

Note:

- ◆ You can enter a frequency in the range of 30.00 kHz to 59.999.99 MHz. Refer to the specifications for the available frequency range.
- ◆ Attempting to enter a frequency that is outside the selectable frequency range causes an alarm to sound. The entered frequency is rejected.
- ◆ When the entered frequency does not meet the current VFO frequency step size requirement, the nearest available frequency is automatically selected after the entered frequency is changed.
- ◆ When the 10 Hz digit (last displayed digit) is entered, the digit 0 is automatically entered for the 1 Hz digit, and frequency entry is completed. The 1 Hz digit is not displayed.
- ◆ When an entered frequency is accepted, RIT or XIT will be switched OFF, but the RIT or XIT offset frequency is not cleared.

■ Using the MHz key

Pressing **[v]/ [^]** on the Remote Control panel changes Amateur bands. You can also use the **MULTI** control to change the operating frequency in steps of 1 MHz.

1 Press **[MHz]**.

- “MHz” appears.

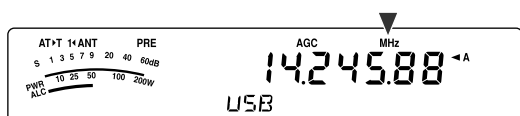

2 Turn the **MULTI** control.

- Clockwise increases the frequency and counter-clockwise decreases the frequency.

3 Press **[MHz]** again to exit.

- “MHz” disappears.

If you prefer to change the frequency in steps of 100 kHz or 500 kHz rather than 1 MHz, press **[MHz]** (1 s), then turn the **MULTI** control to select 100 kHz, 500 kHz, or 1 MHz.

Note: Even if 100 kHz or 500 kHz is assigned for the **[MHz]** key, “MHz” appears on the display.

■ Quick QSY

To move up or down the frequency quickly, use the **MULTI** control. Turning this control changes the operating frequency in steps of 5 kHz for SSB/ CW/ AM/ FSK and 10 kHz for FM.

- If you want to change the default frequency step size, press **[FINE/ STEP]** (1 s). Turn the **MULTI** control to select 5 kHz, 6.25 kHz, 10 kHz, 12.5 kHz, 15 kHz, 20 kHz, 25 kHz, 30 kHz, 50 kHz or 100 kHz for FM/ AM, and 500 Hz, 1 kHz, 2.5 kHz, 5 kHz, or 10 kHz for the other modes. The default frequency step size is 5 kHz for SSB/ CW/ FSK/ AM and 10 kHz for FM.
- When changing the operating frequency by using the **MULTI** control, frequencies are rounded such that new frequencies are multiples of the frequency step size. To disable this function, access Menu No. 05 and select “oFF” (default is ON).
- Within the AM broadcast band, the step size automatically defaults to the frequency step value in Menu No. 06. This frequency step size can be switched between 9 kHz (all E-types: “on”) and 5 kHz (K-type: “oFF”) via Menu No. 06.

Note: The programmed frequency step size for the **MULTI** control is stored independently for the HF and 50 MHz bands. You can also set a different frequency step size for SSB/ CW/ FSK, AM and FM modes.

■ Configuring the Tuning Control as MULTI control (FM)

In FM mode, you can configure the **Tuning** control to change the frequency as same as the **MULTI** control. Access Menu No. 04 and select “on” (default is OFF). As you turn the **Tuning** control, the frequency changes as same as turning the **MULTI** control.

■ Fine Tuning

The default frequency step size when turning the **Tuning** control to change the frequency is 10 Hz for SSB, CW, and FSK modes, and 100 Hz for FM and AM modes. However, you can change the frequency step size to 1 Hz for SSB, CW, and FSK modes, and 10 Hz for FM and AM modes.

1 Press [FINE/ STEP].

- “FINE” appears.

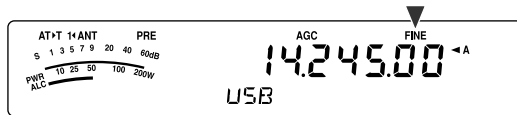

- 2 Turn the **Tuning** control to select the exact frequency.
- 3 To quit the function, press [FINE/ STEP] again.
 - “FINE” disappears.

■ Tuning control adjustment rate

The default **Tuning** control adjustment rate is 500. This represents the number of pulses the **Tuning** control generates in a complete revolution. Each pulse changes the tuning frequency based on the current frequency step size (the frequency step size for the **Tuning** control is 10 Hz for SSB/ CW/ FSK mode and 100 Hz for AM/ FM mode). For example, in SSB mode the frequency step size is 10 Hz, so the frequency would change by 5,000 Hz in a complete revolution of the **Tuning** control. The adjustment rate of the **Tuning** control can be lowered to 250 pulses per revolution or increased to 1000 pulses per revolution.

- 1 Press [MENU/ F.LOCK].
- 2 Turn the **MULTI** control to select Menu No. 03.
- 3 Press [V]/ [^] to select “250”, “500” (default), or “1000”.
- 4 Press [MENU/ F.LOCK] to store the setting and exit Menu mode.

■ Equalizing VFO Frequencies (A=B)

This function allows you to copy the frequency and modulation mode of the active VFO to the inactive VFO.

- 1 Select the frequency and mode on VFO A or VFO B.
- 2 Press [A=B/ SPLIT].
 - The frequency and mode selected in step 1 are duplicated to the inactive VFO.
- 3 Press [A/B / M/V] to confirm that the frequency was copied to other VFO.

RIT (RECEIVE INCREMENTAL TUNING)

RIT provides the ability to change your reception frequency by ± 9.99 kHz in steps of 10 Hz without changing your transmission frequency. If the Fine Tuning ([FINE/ STEP]) function is ON, the frequency

step size becomes 1 Hz. RIT works equally well with all modulation modes and while using VFO or Memory Recall mode.

1 Press [RIT].

- “RIT” and the RIT offset appear.

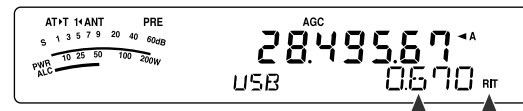

- 2 If required, press [CL] to reset the RIT offset to 0.
- 3 Turn the **RIT/ XIT** control to change your reception frequency.
- 4 To turn RIT OFF, press [RIT].
 - The reception frequency is returned to the frequency that was selected prior to step 1.

Note: When storing the frequency in a Memory channel with the RIT function ON, the RIT offset frequency is added or subtracted to/ from the VFO frequency. The calculated data is then stored in the Memory channel.

AGC (AUTOMATIC GAIN CONTROL)

When using a mode other than FM, AGC selects the time constant for the Automatic Gain Control circuit.

Selecting a slow time constant will cause the receiver gain and S-meter readings to react slowly to large input changes. A fast time constant causes the receiver gain and the S-meter to react quickly to changes in the input signal. A fast AGC setting is particularly useful in the following situations:

- Tuning rapidly
- Receiving weak signals
- Receiving high-speed CW

For your convenience, the following default AGC time constant has already been programmed.

SSB: Slow (“AGC”) CW: Fast (“AGC - F”)
FSK: Fast (“AGC - F”) AM: Slow (“AGC”)

To change the default time constant:

1 Press [AGC/ 0/ OFF].

- The AGC time constant icon appears on the display (“AGC”: Slow, “AGC - F”: Fast).

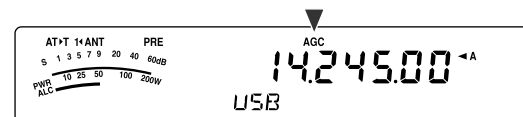

- Each time you press [AGC/ 0/ OFF], the AGC time constant alternates fast and slow.

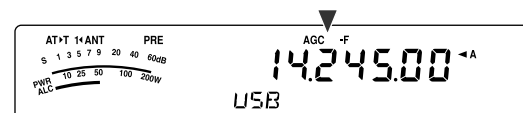

- 2 If you want to turn the AGC OFF, press [AGC/ 0/ OFF] (1 s).
 - “AGC OFF” appears on the display.

Note: You cannot adjust the AGC time constant in FM mode.

TRANSMISSION

VOX (VOICE-OPERATED TRANSMIT)

VOX eliminates the necessity of manually switching to the transmission mode each time you want to transmit. The transceiver automatically switches to transmission mode when the VOX circuitry senses that you have begun speaking into the microphone.

When using VOX, develop the habit of pausing between thoughts to allow the transceiver to drop back to reception mode briefly. You will then hear if anybody wants to interrupt, plus you will have a short period to gather your thoughts before speaking again. Your listeners will appreciate your consideration as well as respect your more articulate conversation.

VOX can be switched ON and OFF independently for CW and the other modes, excluding FSK.

Press **[VOX/ 8]** to toggle between VOX ON and OFF.

- “VOX” appears when the VOX function is ON.

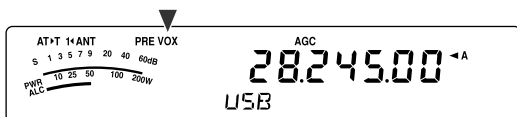

Microphone Input Level

To enjoy the VOX function, take the time to properly adjust the gain of the VOX circuit. This level controls the capability of the VOX circuit to detect the presence or absence of your voice. In CW mode, this level cannot be adjusted.

- 1 Select USB, LSB, FM, or AM mode.
- 2 Press **[VOX/ 8]** to switch the VOX function ON.
 - “VOX” appears.



- 3 Press **[VOX/ 8]** (1 s).
 - The current VOX gain level appears on the sub-display.

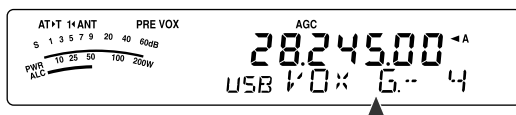

- 4 While speaking into the microphone using your normal tone of voice, adjust the setting (default is 4) using the **MULTI** control until the transceiver reliably switches to transmission mode each time you speak.
 - The selectable gain range is from 0 to 9.
 - The setting should not allow background noise to switch the transceiver to transmit mode.

Note: The VOX gain level can be adjusted even if VOX is switched OFF or while you are transmitting.

Delay Time

If the transceiver returns to reception mode too quickly after you stop speaking, your final word may not be transmitted. To avoid this, select an appropriate delay time that allows all of your words to be transmitted without an overly long delay after you stop speaking.

- 1 Select USB, LSB, FM, or AM mode.
- 2 Press **[VOX/ 8]** to switch the VOX function ON.
 - “VOX” appears.
- 3 Press **[KEY/ DELAY]** (1 s).
 - The current setting appears on the sub-display. The default is 50 (1500 ms).

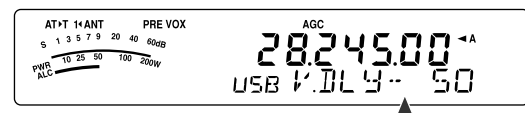

- 4 While speaking into the microphone using your normal tone of voice, turn the **MULTI** control such that the transceiver switches to reception mode after you have stopped talking.
 - The selectable range is from 5 to 100 (150 ms to 3000 ms) in steps of 5, or OFF.
- 5 Press **[MTR/ CLR]** to store the parameter and exit the setting mode.

Anti-VOX adjustment

The TS-480 transceiver has a DSP IC to improve and customize incoming/ outgoing audio signals. When VOX function is turned ON, the DSP IC adjusts the Anti-VOX level automatically, comparing the reception sound level and microphone input level. So, you never have to worry about adjusting the anti-VOX level.

VOX Source

Although microphone is normally used to perform the VOX transmission, you can also utilize AF input of the **DATA** connector (pin 1) on the TX/ RX unit {page 78}. When the transceiver detects the audio signal on the pin 1 of **DATA** connector, the transceiver automatically transmits.

- 1 Select USB, LSB, FM, or AM mode.
- 2 Press **[VOX/ 8]** to switch the VOX function ON.
 - “VOX” appears.
- 3 Press **[MENU/ F.LOCK]** and turn **MULTI** control to select Menu No. 60.
- 4 Press **[^]** to switch the VOX with DATA input function ON.
- 5 Turn **MULTI** control to select Menu No. 46.
- 6 While sending AF signal to pin 1 of DATA connector, adjust the value (default is 4) using **[^]**/ **[v]** until the transceiver reliably switches to transmit mode each time you send AF signal to pin 1 of DATA connector.

Note: VOX function does not work even if you speak into the microphone. However, you can transmit with the Mic **[PTT]**.

SPEECH PROCESSOR

The Speech Processor levels out large fluctuations in your voice while you speak. When using SSB, FM, or AM mode, this leveling action effectively raises the average TX power, resulting in a more understandable signal. The amount of voice compression is fully adjustable. You will notice that using the Speech Processor makes it easier to be heard by distant stations.

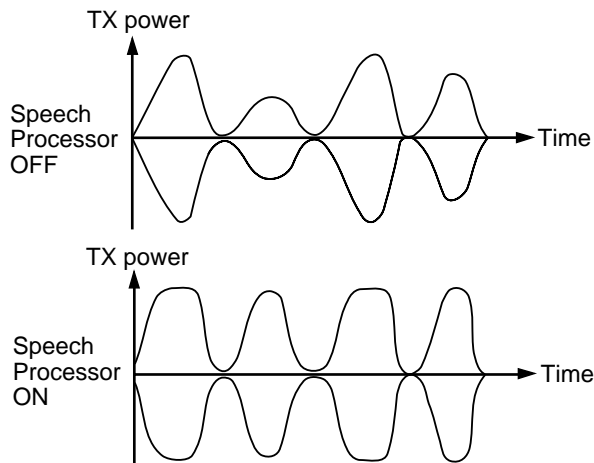

- 1 Select USB, LSB, FM, or AM mode.
- 2 Press **[PROC/ 9]** to turn the Speech Processor ON.
 - “PROC” appears.
- 3 Press **[PROC/ 9] (1 s)** to enter the Speech Processor input level adjustment mode.
- 4 As you speak into the microphone, turn the **MULTI** control so that the compression meter indicates that the compression level is around 10 dB while you speak.
 - Using higher compression will not improve your signal clarity or apparent signal strength. Excessively compressed signals are more difficult to understand due to distortion and are less pleasant to hear than signals with less compression.
- 5 Press **[PROC/ 9] (1 s)** to exit the Speech Processor input level adjustment mode.
- 6 Press **[MIC/ 5/ RF.G]** to enter the Speech Processor output level adjustment mode.
 - As you speak into the microphone, turn the **MULTI** control so that the ALC meter reflects according to your voice level but does not exceed the ALC limit. Press **[MIC/ 5/ RF.G]** to exit when you finish the adjustment mode.

XIT (TRANSMIT INCREMENTAL TUNING)

Similar to RIT, XIT provides the ability to change your transmission frequency by ± 9.99 kHz in steps of 10 Hz without changing your reception frequency. If the Fine Tuning function is ON, the frequency step size becomes 1 Hz.

- 1 Press **[XIT]**.

- “XIT” and the XIT offset appear.

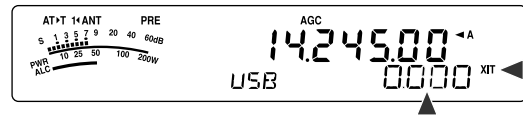

- 2 If required, press **[CL]** to reset the XIT offset to 0.
- 3 Turn the **RIT/ XIT** control to change your transmit frequency.

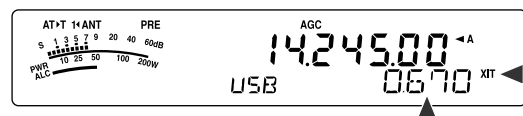

- 4 To turn XIT OFF, press **[XIT]**.

- “XIT” and offset frequency display disappear. The transmission frequency is returned to the frequency that was selected prior to step 1.

Note:

- ◆ If the Fine Tuning function is ON, you can adjust the frequency within ± 9.99 kHz.
- ◆ The frequency shift set by the XIT control is also used by the RIT function. Therefore, changing or clearing the XIT offset also affects the RIT offset.
- ◆ When the XIT frequency exceeds the limit of available transmission frequency, the transceiver automatically stops transmitting.

8 COMMUNICATING AIDS

CUSTOMIZING TRANSMISSION SIGNAL CHARACTERISTICS

The quality of your transmission signal is important, regardless of which on-air activity you pursue. However, it is easy to be casual and overlook this fact since you don't listen to your own signal. The following sub-sections provide information that will help you tailor your transmission signal.

■ TX Filter Bandwidth (SSB/ AM)

Use Menu No. 20 to select one of the following TX filter bandwidths: 2.0 kHz or 2.4 kHz (default).

Display	Bandwidth	Passband frequency
2.0	2.0 kHz	500 ~ 2500 Hz
2.4	2.4 kHz	300 ~ 2700 Hz

■ TX Equalizer (SSB/ FM/ AM)

Use Menu No. 19 to change the transmission frequency characteristics of your signal. You can select from one of 6 different transmission profiles including the default flat response. Selecting any of the following items from the Menu causes "EQ▶T" to appear on the display.

- **Off (oFF):**
The flat frequency response for SSB, FM, and AM (default).
- **High boost 1 (Hb1)/ High boost 2 (Hb2):**
Emphasizes higher audio frequencies; effective for a bassy voice. High boost 2 does not reduce the low frequency as much as High boost 1.
- **Formant pass (FP):**
Improves clarity by suppressing audio frequencies outside the normal voice frequency range.
- **Bass boost 1 (bb1)/ Bass boost 2 (bb2):**
Emphasizes lower audio frequencies; effective for a voice with more high frequency components. Bass boost 2 emphasises more low frequency response.
- **Conventional (c):**
Emphasizes by 3 dB frequencies at 600 Hz and higher.
- **User (U):**
Reserved for the optional ARCP software. Off (oFF) is programmed at the factory as a default.

Frequency Response Curves

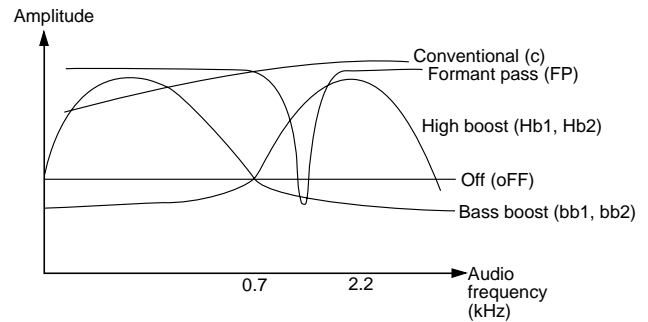

TRANSMIT INHIBIT

Transmit Inhibit prevents the transceiver from being placed in transmission mode. No signal can be transmitted when this function is ON even if Mic [PTT] is pressed.

- **TX Inhibit OFF:** Transmission is allowed.
- **TX Inhibit ON:** Transmission is not allowed.

Switch the function ON or OFF via Menu No. 55. The default is OFF.

BUSY LOCKOUT

Busy Lockout prevents the transceiver from being placed in transmit mode. Transmission is not allowed if the current operating frequency is busy (in other words, the squelch is open).

- **Busy Lockout OFF:** Transmission is allowed.
- **Busy Lockout ON:** Transmission is not allowed.

Switch the function ON or OFF via Menu No. 58. The default is OFF.

CHANGING FREQUENCY WHILE TRANSMITTING

Moving your frequency while transmitting is usually an unwise practice due to the risk of interfering with other stations. However, if necessary, by using the **Tuning** control you can change the operating frequency while transmitting. You also can change the XIT offset frequency while in transmission mode.

While transmitting, if you select a frequency outside the transmission frequency range, the transceiver is automatically forced to return to the reception mode. If you selected transmission mode by pressing Mic [PTT], transmission will not resume until you select a frequency inside the transmission frequency range, at which time you must release and press Mic [PTT] again.

CW BREAK-IN

Break-in allows you to transmit CW without manually switching between transmission and reception modes. Two types of Break-ins are available: Semi Break-in and Full Break-in.

Semi Break-in:

When the key contacts open, the transceiver automatically waits for the passage of the time period that you have selected. The transceiver then returns to reception mode.

Full Break-in:

As soon as the key contacts open, the transceiver returns to reception mode.

USING SEMI BREAK-IN OR FULL BREAK-IN

- 1 Press **[MODE]** until you select CW mode.
 - “CW” or “CWR” appears.
- 2 Press **[VOX/ 8]**.
 - “VOX” appears.
- 3 Press **[KEY/ 6/ DELAY] (1 s)**.
 - The current setting (FBK or delay time) appears. The default is FBK (Full Break-in).

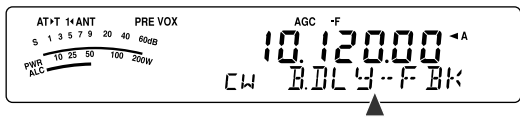

- 4 Turn the **MULTI** control to select “FBK” (Full Break-in) or a delay time for Semi Break-in.
 - Delay time ranges from 5 to 100 (50 ms to 1000 ms) in steps of 5.

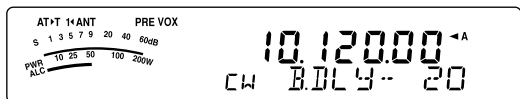

- 5 Begin sending.
 - The transceiver automatically switches to transmission mode.
 - **When FBK (Full Break-in) is selected:** The transceiver immediately switches to reception mode when the key opens.
 - **When a delay time is selected:** The transceiver switches to reception mode after the delay time that you have selected has passed.
- 6 Press **[MTR/ CLR]** to exit.

Note: FBK (Full Break-in) cannot be used with the TL-922/ 922A linear amplifier.

ELECTRONIC KEYS

This transceiver has a built-in electronic keyer that can be used by connecting a keyer paddle to the transceiver’s rear panel. Refer to “Keys for CW (PADDLE and KEY)” {page 7} for details regarding this connection. The built-in keyer supports lmbic (squeeze) operation.

CHANGING KEYING SPEED

The keying speed of the electronic keyer is fully adjustable. Selecting the appropriate speed is important in order to send error-free CW that other operators can copy solidly. Selecting a speed that is beyond your keying ability will only result in mistakes. You will obtain the best results by selecting a speed that is close to the speed used by the other station.

- 1 Press **[MODE]** until you select CW mode.
 - “CW” or “CWR” appears.
- 2 Press **[KEY/ 6/ DELAY]**.
 - The current keying speed appears. The default is 20 (WPM).

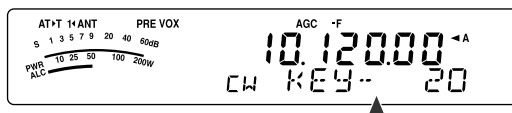

- 3 While keying the paddle and listening to the TX (transmission) sidetone, turn the **MULTI** control to select the appropriate speed.
 - The speeds range from 10 (WPM) to 60 (WPM), in steps of 1 (WPM). The larger the number, the faster the speed.
- 4 Press **[KEY/ 6/ DELAY]** again to complete the setting.

Note: When using the semi-automatic “Bug” function, the selected speed applies only to the rate that dots are sent.

AUTO WEIGHTING

The electronic keyer can automatically change the dot/ dash weighting. Weighting is the ratio of dash length to dot length. The weighting changes with your keying speed automatically, thus making your keying easier for other operators to copy (default).

Access Menu No. 35 to select “AUto” or “2.5” ~ “4.0” (in steps of 0.1) fix weight ratio. The default is AUTO. When the fix weight ratio is selected, the dot/ dash weight ratio is locked regardless of the keying speed.

Reverse Keying Weight Ratio

Auto Weighting increases the weighting as you increase your keying speed. However, the electronic keyer also can decrease the weighting as you increase your keying speed.

To switch this function ON, access Menu No. 36, and select “on”. The default is OFF.

Reverse Keying Weight	Keying Speed (WPM)		
	10 ~ 25	26 ~ 45	46 ~ 60
OFF	1:2.8	1:3.0	1:3.2
ON	1:3.2	1:3.0	1:2.8

8 COMMUNICATING AIDS

BUG KEY FUNCTION

The built-in electronic keyer also can be used as a semi-automatic key. Semi-automatic keys are also known as “Bugs”. When this function is ON, dots are generated in the normal manner by the electronic keyer. Dashes, however, are manually generated by the operator by holding the keyer paddle closed for the appropriate length of time.

To switch this function ON, access Menu No. 37 and select “on”. The default is OFF.

Note: When the Bug Key function is ON, CW Message Memory (see below) cannot be used.

CW MESSAGE MEMORY

This transceiver has 3 memory channels for storing CW messages. Each memory channel can store approximately 50 characters (equivalent of 250 dots). These memory channels are ideal for storing contest exchanges that you want to send repeatedly. Stored messages can be played back to check message content or for transmitting.

The electronic keyer has a function that allows you to interrupt playback and manually inject your own keying. To switch this function ON, access Menu No. 33 and select “on”. The default is OFF.

The electronic keyer can also repeatedly play back the message that you stored. To switch this function ON, access Menu No. 31 and select “on”. The default is OFF.

For repetitive message playback, you can change the interval between each series of messages. Use Menu No. 32 and select the time in the range of 0 to 60 seconds in steps of 1 second {page 41}.

Note:

- ◆ This function cannot be used when the Bug Key function is ON.
- ◆ Operating the keyer paddle with Menu No. 33 OFF cancels message playback. Even if message playback does not stop because of your keying start timing, you can cancel playback by pressing [MTR/ CLR].

■ Storing CW Messages

- 1 Press [MODE] until you select CW mode.
 - “CW” or “CWR” appears.
- 2 If VOX is ON, press [VOX/ 8].
 - “VOX” disappears {page 39}.
- 3 Press [CH1/ 1/ REC] (1 s), [CH2/ 2/ REC] (1 s) or [CH3/ 3/ REC] (1 s) to select a memory channel to be recorded.

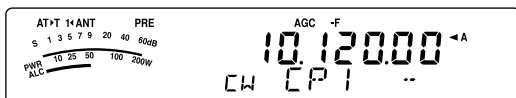

- If the Constant Recording is ON (Menu No. 30), you cannot store a message to CH3 {page 69}.
- 4 Begin sending using the keyer paddle.
 - The message you send is stored in memory.

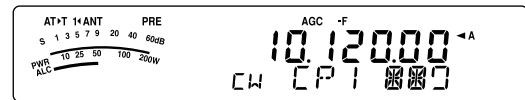

- 5 To complete the message storage, press [MTR/ CLR] to stop.
 - When the memory becomes full, recording automatically stops.

Note:

- ◆ If you do not operate the keyer paddle after starting to record a message, a pause is stored in the channel.
- ◆ When the optional VGS-1 is installed and the Constant Recording function is working, CH3 cannot be used.

■ Checking CW Messages without Transmitting

- 1 Press [MODE] until you select CW mode.
 - “CW” or “CWR” appears.
- 2 If VOX is ON, press [VOX/ 8] to switch it OFF.
- 3 Press [CH1/ 1/ REC], [CH2/ 2/ REC] or [CH3/ 3/ REC] to select the channel to be played back.
 - The message is played back.
 - To play back the messages stored in the other channels in sequence, press the corresponding channel keys during playback. Up to 3 channels can be queued at the same time.

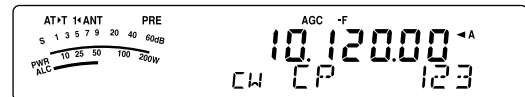

- While playing back the messages, you can also adjust the keyer speed by pressing [KEY/ 6/ DELAY] and turning the MULTI control.
- To interrupt playback, press [MTR/ CLR].

■ Transmitting CW Messages

Messages can be transmitted using Semi Break-in/ Full Break-in or manual TX/ RX switching.

- 1 Press [MODE] until “CW” or “CWR” appears.
- 2 To use Semi Break-in/ Full Break-in, press [VOX/ 8].
 - “VOX” appears.
- 3 Press [CH1/ 1/ REC], [CH2/ 2/ REC] or [CH3/ 3/ REC] to select the channel to be played back.
 - The message is played back and transmitted automatically.
 - To transmit the messages stored in the other channels in sequence, press the corresponding channel keys during playback. Up to 3 channels can be queued at the same time.
 - While playing back the messages, you can also adjust the keyer speed by pressing [KEY/ 6/ DELAY] and turning the MULTI control.
 - To interrupt transmission, press [MTR/ CLR].

■ Changing the Inter-message Interval Time

For the message playback repeat, access Menu No. 31 and select "on". You can also change the interval playback time of the message. Access Menu No. 32 and select the time in the range of 0 to 60 seconds in steps of 1 second.

Note: Menu Nos. 31 and 32 settings are shared with the voice communication modes when the optional VGS-1 is installed.

■ Changing the CW Sidetone Volume

Turning the **AF** control does not change the CW sidetone playback volume. To change the CW sidetone volume, access Menu No. 13 and select "oFF", or "1" to "9".

■ Insert Keying

If you operate a CW keyer manually while playing back a recorded CW message, the transceiver stops playing back the message. However, during contests or regular QSOs, you may sometimes want to insert a different number or message at a certain point in the recorded message.

In this case, first record the CW message as usual {page 40}, without the number or message you want to insert. Then, access Menu No. 33 and select "on".

Now if you operate a CW keyer while you play back a recorded message, the transceiver pauses the playback of the recorded message, instead of stopping it. When you finish sending the number or message with the keyer, the transceiver resumes playback of the message.

FREQUENCY CORRECTION FOR CW

If you operate both SSB and CW modes, you would sometimes use SSB mode (USB or LSB) just to watch and listen to CW signals. It is fine just to monitor those CW signals but you have experienced that changing the mode from SSB to CW results in losing the target CW signal. This is because the frequency on the display always shows the true carrier frequency for all modes. If you want the transceiver to shift the reception frequency to trace the receiving CW signal when changing the mode from SSB (USB or LSB) to CW, switch this function ON. The transceiver shifts the reception frequency when changing the mode from SSB to CW, so you can still hear the target signal and instantly transmit the signal in CW without adjusting the frequency.

- 1 Press **[MENU/ F.LOCK]**, then turn the **MULTI** control to access Menu No. 40.
- 2 Press [**^**] to select "on".
- 3 Press **[MENU/ F.LOCK]** to store the settings and exit the Menu mode.

AUTO CW TX IN SSB MODE

If you operate both SSB and CW modes, you can configure the transceiver to change the operating mode from SSB (USB or LSB) to CW and then transmit in CW mode automatically when you operate the CW keyers.

- 1 Press **[MENU/ F.LOCK]**, then turn the **MULTI** control to access Menu No. 39.
- 2 Press [**^**] to select "on".
- 3 Press **[MENU/ F.LOCK]** to store the settings and exit the Menu mode.

Note: You must switch the CW Break-in function ON to change the mode and transmit in CW mode {page 39}.

MIC UP/ DWN KEY PADDLE MODE

This function allows you to send CW message without using an optional paddle {page 7}. Mic **[UP]** key can be used as dot paddle and Mic **[DWN]** key can be used as a dash paddle.

To activate Mic UP/ DWN key Paddle mode:

- 1 Turn the transceiver OFF.
- 2 Press Mic **[UP]** or Mic **[DWN]+[⏻]** (POWER).
 - Press and hold Mic **[UP]** to send dots or Mic **[DWN]** to send dashes in CW mode.

To exit Mic UP/ DWN key Paddle mode, perform step 1 and 2 again.

SWAP DOT AND DASH PADDLE POSITION

This function reverses the position of the dot and dash paddle positions. As a default, the left paddle sends dots and the right paddle sends dashes. This function reverses these positions. When this function is ON, the left paddle sends dashes and the right paddle sends dots.

- 1 Press **[MENU/ F.LOCK]**.
- 2 Turn the **MULTI** control to select Menu No. 38.
- 3 Press [**^**] to select "on".
- 4 Press **[MENU/ F.LOCK]** to store the setting and exit Menu mode.
 - The left paddle now sends dashes and the right paddle now sends dots. To return to the normal paddle positions, select "oFF" in step 3.

RADIO TELETYPE (RTTY)

RTTY is the data communications mode with the longest history. It was originally designed for use with mechanical teletypewriters which were often used before personal computers became common. Now you can easily start operating RTTY with a personal computer and MCP. Unlike Packet, each time you type a letter, it is transmitted over the air. What you typed is transmitted and displayed on the computer screen of the recipient.

RTTY operation uses frequency shift keying (FSK) and the 5-bit Baudot code or the 7-bit ASCII code to transmit information.

For the cable connections, refer to "RTTY OPERATION" {page 77}.

For further information, consult reference books about Amateur Radio.

- 1 Access Menu No. 41 and select an FSK shift.
 - FSK shift is the difference in frequencies between a mark and a space.
 - The 170 Hz shift (default) is normally used on the Amateur bands for the RTTY.
- 2 Access Menu No. 42 and select a key-down polarity.
 - Select "oFF" (default) to transmit a mark when keying down or "on" to transmit a space.
- 3 Access Menu No. 43 and select "2175" (high tone) or "1275" (low tone) for mark.
 - High tone (default) is commonly used nowadays.
- 4 Select an operating frequency.
- 5 Press **[MODE]** to select FSK mode {page 19}.
 - If necessary, access Menu No. 47 to configure the appropriate audio output level for your MCP. The audio output level of ANO (**REMOTE** connector/ pin 5) changes {page 78}. The **AF** control cannot be used to adjust the audio level for your MCP.



- 6 Some stations may be operating in Reverse shift. In this case, press **[MODE]** (1 s) to reverse the shift (the upper sideband is used).
 - "FSR" appears.

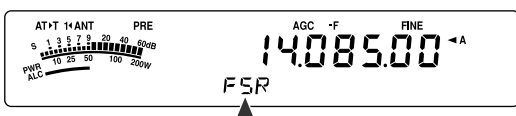

- Traditionally, the lower sideband is used for FSK operation. Press **[MODE]** (1 s) again to return to the lower sideband. "FSK" appears.

- 7 Follow the instructions provided with your MCP and enter a command from your computer to transmit.
 - The LED changes from green (RX) to red (TX).
- 8 Begin sending data from your computer.
 - Press **[PWR/ 4/ TX MONI]** (1 s) to monitor your signals. Press **[PWR/ 4/ TX MONI]** (1 s) again to quit this function.
- 9 When finished transmitting, enter a command from your computer to return to reception mode.
 - The LED changes from red (TX) to green (RX).

The following frequencies (measured in kHz) commonly used for RTTY operation:

U.S.A./ Canada	ARU Region 1 (Europe/ Africa)
1800 ~ 1840	1838 ~ 1842
3605 ~ 3645 (DX: 3590)	3580 ~ 3620
7080 ~ 7100 (DX: 7040)	7035 ~ 7045
10140 ~ 10150	10140 ~ 10150
14070 ~ 14099.5	14080 ~ 14099.5
18100 ~ 18110	18101 ~ 18109
21070 ~ 21100	21080 ~ 21120
24920 ~ 24930	22920 ~ 24929
28070 ~ 28150	28050 ~ 28150

Note: The TS-480 transceiver utilizes the DSP IC to generate a variety of the required audio tones for RTTY operation (AFSK).

AMTOR/ PacTOR/ CLOVER/ G-TOR/ PSK31

Besides RTTY, digital modes which have been used among hams include AMTOR, PacTOR, CLOVER, G-TOR, and PSK31. For details, consult reference books about the digital mode communications of amateur radio.

AMTOR (AMateur Teleprinting Over Radio) has brought amateur HF digital communication into the computer age. It is the first error-free HF digital mode by which data bursts (not steady stream of data) are transmitted.

PacTOR (Packet Teleprinting On Radio) has combined the best features of both AMTOR and Packet to improve the efficiency of HF digital communications. Like Packet and AMTOR, PacTOR sends error-free data using a handshaking method.

Of all the Amateur Radio HF digital modes, CLOVER offers the best overall performance using a complicated modulation technique, automatic power adjustment and other advanced features. It may allow communications to be maintained under the worst conditions.

G-TOR (Golay-coded Teleprinting Over Radio) is a relatively new Amateur Radio digital mode currently in use. G-TOR was developed specifically to handle the adverse conditions of communicating across the solar system with spacecraft during their missions.

PSK31 was developed by an RTTY enthusiast, G3PLX, in the United Kingdom. The operating technique is very similar to the conventional Baudot-RTTY, although more sensitive fine-tuning is required, as a PSK31 signal requires a tuning accuracy of a few Hertz. A special feature of PSK31 is that it allows the entire ASCII character set, including the back space character.

Your MCP should handle some or all of the above modes. For available modes on your MCP, consult the instruction manual for the MCP. For the cable connections, refer to "MCP AND TNC" {page 78}.

On most HF bands, audio frequency shift keying (AFSK) is used for the above modes. This method of modulation uses audio tones, therefore either LSB or USB mode should be selected. Traditionally, LSB is used, similar to RTTY, with the exception of AMTOR which is normally operated in USB.

AMTOR activity can be found on or near 14075 kHz and 3637.5 kHz. These are also good starting places when searching for PacTOR, CLOVER, G-TOR, or PSK31 stations.

The TS-480 transceiver has special DSP filters for these digital modes. Refer to page 48 for details.

Note: When using SSB mode for digital operation, use a fast AGC setting and switch your Speech Processor OFF.

PACKET RADIO

Packet is a unit of data transmitted as a whole from one computer to another, on a network. Packets can be transmitted on radio waves as well as on communications lines. Besides a transceiver and a computer, all you need is a terminal node controller (TNC) or Multimode Communications Processor (MCP). One of the tasks of TNCs and MCPs is to convert data packets to audio tones, and vice versa. Connecting a TNC to this transceiver allows you to use many packet applications.

A variety of packet applications developed by hams include packet bulletin board systems (PBBSs). PBBSs are created and maintained by volunteers called System Operators (SysOp). You may access one of your local PBBSs to send e-mail, download files, or obtain various useful information. Thousands of PBBSs, which have formed a worldwide network, relay e-mail to their intended destinations around the world.

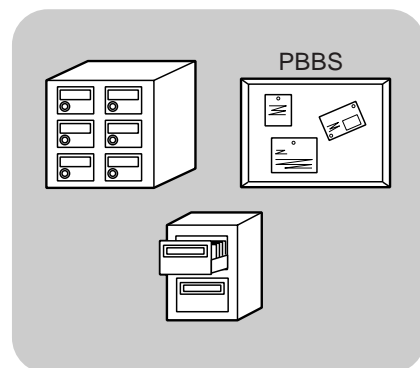

When you access a local PBBS for the first time, you often need to register as a new user. After you are successfully registered, it will then be available as your home PBBS. E-mail addressed to you will be held under a directory, called a mailbox, on your home PBBS.

For further information, consult reference books which should be available at any store that handles Amateur Radio equipment. Web pages relating to Packet will also be helpful. On Internet search engines, use "Packet Radio" as key words to find those Web pages.

Note:

- ◆ Unlike a TNC, a Multimode Communications Processor (MCP) serves as a communications interface in several digital modes such as Packet, RTTY, and AMTOR. You can cause it to switch among the modes by sending a single command from your computer.
- ◆ If there is an amateur radio club in your area, consider becoming a member. You can often learn more in an hour from experienced hobbyists, than in a month of independent research. Ask on the local repeaters or contact your national amateur radio organization (the ARRL in the U.S.A.) for information on local amateur radio clubs. You'll be glad you did.

SLOW SCAN TV/ FACSIMILE

Slow-scan Television (SSTV) is a popular application for transmitting still images over the air, from one station to another. Instead of trying to describe your station, simply showing it is much faster. Transmitting images over the air requires a scan converter, besides a transceiver. A scan converter transforms images taken with a video camera into audio signals that can be fed into your transceiver. The recipient's scan converter transforms audio signals back into video images so that he or she can view them on a TV set.

Nowadays instead of a scan converter, many hams use a personal computer, a software application, and an interface attached to the transceiver. This is much cheaper, more flexible, and does not require a TV set. In recent years, many low cost digital cameras have become available. You can transfer images from these cameras into your computer.

For further information, consult reference books about Amateur Radio. The frequencies (measured in kHz) commonly used for SSTV operation are listed below:

U.S.A./ Canada	ARU Region 1 (Europe/ Africa)
3845, 3857	3730 ~ 3740
7171	7035 ~ 7045
14230, 14233	14225 ~ 14235
21340	21335 ~ 21345
28680	28675 ~ 28685
145500	—

Fax (facsimile) is one of the original image transmission modes. Using this mode allows you to exchange more detailed graphics than SSTV. Amateur Radio fax functions much like old analog fax systems. It scans paper and converts acquired image data into a series of tones representing white and black portions of the image. Because fax requires longer transmission time, you should use it only when band conditions are stable with strong signals.

Popular fax frequencies include the following:

- 7245, 14245, 21345 (International Net), and 28945 kHz

Operating on SSTV or fax mainly involves learning the functionality of your computer application or accessory hardware that supports these modes. Consult the instruction manual that comes with your software or accessory equipment.

Note: *When operating either SSTV or fax, use a fast AGC setting and switch OFF your Speech Processor, for best results.*

REJECTING INTERFERENCE

IF FILTER

The IF filters are designed for selecting the exact range of intermediate frequencies that are sent to the next stage in the receive circuit. Interference adjacent to the desired signal can be reduced by selecting a narrow bandwidth filter and/ or shifting the center frequency of the filter.

To more effectively remove interference, combine the IF filtering and the DSP filtering (AF) described on pages 46 and 47.

CHANGING THE IF FILTER BANDWIDTH

When adjacent frequency interference is present at both sides of the desired signal, narrowing IF filter bandwidth may be the best way to remove the interference. Changing the filter bandwidth will not effect the current reception frequency.

You can install 2 optional IF filters for SSB, CW, and FSK modes. After installing the optional filters {page 81}, the transceiver automatically recognizes what type of optional filters are installed.

■ SSB/ AM

When you operate the transceiver in SSB or AM mode, you can manually select the wide or narrow filter.

Press **[FIL/ NAR] (1 s)** to select another IF filter.

- Each press of **[FIL/ NAR] (1 s)** changes “ ” (Normal) → “**NAR**”, then back to “ ” (Normal).
- If Menu No. 17 is ON (default is OFF) and 2 IF filters have been installed, you can select secondary IF filter. In this case, each press of **[FIL/ NAR] (1 s)** changes “ ” (Normal) → “**NAR**” → “**NAR 2**”, then back to “ ” (Normal).

Mode	IF filter bandwidth	
	Normal	Narrow
SSB	2.4 kHz	1.8 kHz ¹ / 500 Hz ² / 270 Hz ³
AM	6.0 kHz	2.4 kHz

¹ Optional YF-107SN filter must be installed.

² Optional YF-107C filter must be installed and Menu No. 17 must be set to ON.

³ Optional YF-107CN filter must be installed and Menu No. 17 must be set to ON.

■ CW/ FSK

When you operate in CW or FSK mode, the wide filter or narrow filter is automatically selected according to the DSP filter bandwidth that you select.

The following table describes how the optional filter is selected as you change the bandwidth of DSP filter. You cannot manually select the IF filter. To change the DSP filter bandwidth, refer to “CHANGING THE DSP FILTER BANDWIDTH” {page 46}.

IF Filter bandwidth			DSP Filter (AF) bandwidth		
YF-107CN 270 Hz	YF-107C 500 Hz	YF-107SN 1.8 kHz	~ 300 Hz	~ 600 Hz	~ 2.0 kHz
—	—	—	2.4 kHz (Normal)		
—	—	✓	1.8 kHz (Normal)		
—	✓	—	500 Hz (NAR)		2.4 kHz (Normal)
✓	—	—	270 Hz (NAR)	2.4 kHz (Normal)	
—	✓	✓	500 Hz (NAR)		1.8 kHz (Normal)
✓	—	✓	270 Hz (NAR)	1.8 kHz (Normal)	
✓	✓	—	270 Hz (NAR 2)	500 Hz (NAR)	2.4 kHz (Normal)

■ FM

In FM mode, you cannot change the reception IF filter bandwidth. The bandwidth is fixed at 12 kHz.

IF SHIFT (SSB/ CW/ FSK)

Shifting the center frequency of the filter pass band is an additional method of removing adjacent frequency interference. Shifting this center frequency does not change the current reception frequency.

To remove interference that is higher in frequency than the desired signal, turn the **IF SHIFT** control counterclockwise. To remove interference that is lower in frequency than the desired signal, turn the **IF SHIFT** control clockwise.

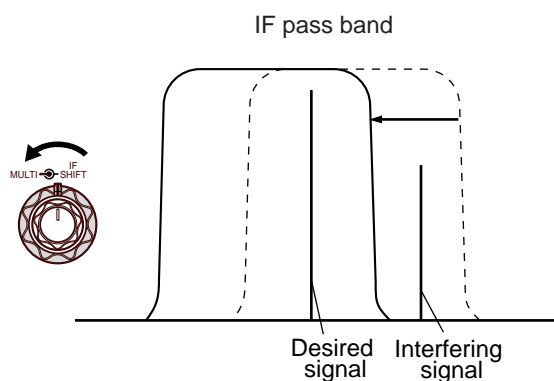

10 REJECTING INTERFERENCE

DSP FILTERS

KENWOOD digital signal processing (DSP) technology is adapted to this transceiver. Using DSP filtering (AF), you can control the bandwidth, cancel the multiple jamming beat, and reduce the noise level using DSP filtering technology.

CHANGING THE DSP FILTER BANDWIDTH

For improving interference reduction capability, this transceiver also provides the DSP filtering (AF) along with IF filters. When in SSB, FM, or AM mode, you can change the filter bandwidth by altering its low and/ or high cut-off frequency. For CW and FSK modes, you can change the filter bandwidth by directly specifying a bandwidth. Changing the DSP filter bandwidth (AF) does not affect the current reception frequency.

■ SSB/ FM/ AM

- 1 Press **[MODE]** to select SSB, FM, or AM mode.
- 2 Press **[FIL/ NAR]**.
 - The current high-cut filter frequency for the mode appears on the sub-display.
- 3 Turn the **MULTI** control clockwise to raise the high cut-off frequency, or counterclockwise to lower the high cut-off frequency.

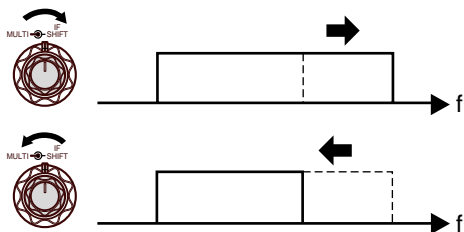

- 4 Press **[FIL/ NAR]** again.
 - The current low-cut filter frequency appears.
- 5 Turn the **MULTI** control clockwise to raise the low cut-off frequency, or counterclockwise to lower the low cut-off frequency.
- 6 To return to the normal operation, press **[FIL/ NAR]** or **[MTR/ CLR]**.

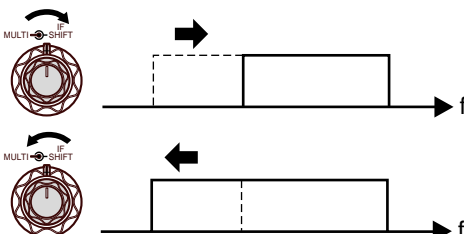

Adjust	Mode	Frequency Selections (Hz)
HI	SSB/ FM	1000, 1200, 1400, 1600, 1800, 2000, 2200, 2400, 2600, 2800, 3000, 3400 (default), 4000, 5000
	AM	2500, 3000 (default), 4000, 5000
LO	SSB/ FM	0, 50, 100 (default), 200, 300, 400, 500, 600, 700, 800, 900, 1000
	AM	0, 100 (default), 200, 500

Note:

- ◆ The cut-off frequencies (LO) can be adjusted independently for each operating mode. When you change the operating mode, the previous setting is recalled for each operating mode.
- ◆ When the DSP filter for data communication (Menu No. 45) is ON, you cannot change the DSP filter bandwidth. Select "oFF" to adjust the DSP filter bandwidth.

■ CW/ FSK

- 1 Press **[MODE]** to select CW or FSK mode.
- 2 Press **[FIL/ NAR]**.
 - The current DSP filter bandwidth (AF) appears.
- 3 Turn the **MULTI** control clockwise to increase (wider) the bandwidth, or counterclockwise to decrease (narrower) the bandwidth.

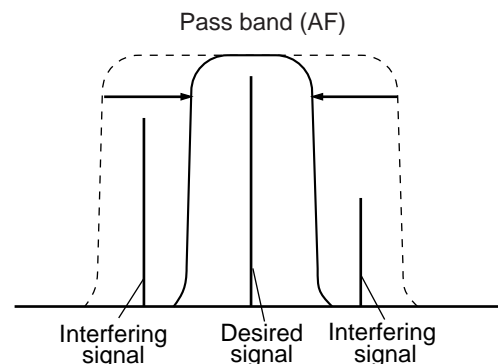

Mode	Bandwidth Selections (Hz)	Default (Hz)
CW	50, 80, 100, 150, 200, 300, 400, 500, 600, 1000, 2000	600
FSK	250, 500, 1000, 1500	1500

- 4 As for CW, you can further adjust the RX pitch frequency. Access Menu No. 34 and turn the **MULTI** control to adjust the RX pitch frequency from 400 to 1000 Hz in steps of 50 Hz. The default RX pitch frequency is 800 Hz {page 29}.
- 5 To return to the current operating mode, press **[MTR/ CLR]** or **[FIL/ NAR]**.

BEAT CANCEL (SSB/ FM/ AM)

Two types of Beat Cancel DSP filters are available. Beat Cancel 1 (BC1) is effective for removing a weak beat or continuous beat signals. Beat Cancel 2 (BC2) is effective for removing intermittent beat signals, such as CW signals.

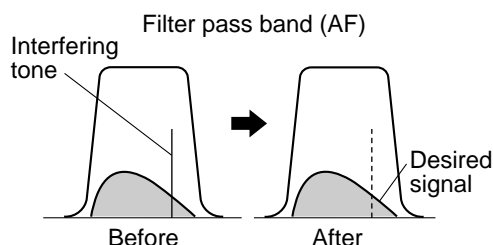

Press **[BC/ CW.T]** to cycle through Beat Cancel 1, Beat Cancel 2, and OFF.

- “1◀BC” or “BC▶2” appears when the Beat Cancel function is ON.
- The interfering beat signals are removed.

NOISE REDUCTION (ALL MODES)

This transceiver provides 2 types of Noise Reduction functions (NR1 and NR2) for reducing random noise which interferes with the desired signal. Trying them both is the easiest way to judge which function works more effectively under the current conditions. Normally, select NR1 (Line Enhanced) in SSB mode and NR2 (SPAC) in CW mode.

Press **[NR]** to toggle between NR1, NR2, and OFF.

- “1◀NR” or “NR▶2” appears, depending on which type of noise reduction filter is selected.

■ Setting the NR1 Level Adjustment

The NR1 (Line Enhanced Method) uses an adaptive filter to reduce the noise element from the received signals. When the S/N ratio is reasonably good in SSB, using the NR1 will improve the S/N further.

While NR1 is ON, you can further adjust the noise reduction level by pressing **[NR] (1 s)**, then turn the **MULTI** control to select the level from 1 to 9 or AUTO. The default is AUTO.

■ Setting the NR2 Time Constant

You can change the correlation time for NR2 (SPAC). When in SSB mode, select the correlation time that allows you to hear signals with clarity. When receiving CW, it is best to select the longest correlation time that allows reliable reception. The longer the correlation time, the better the S/N ratio.

When NR2 is ON, press **[NR] (1 s)**, then turn the **MULTI** control to select the correlation time from 2 ms to 20 ms. The default is 20 ms.

Note: Using Noise Reduction 2 in SSB mode may lower the clarity of signals or induce pulse noise, depending on the conditions.

NOISE BLANKER

Noise Blanker was designed to reduce pulse noise such as that generated by automobile ignitions. Noise Blanker does not function in FM mode.

Press **[NB/T/ 7]** to toggle the Noise Blanker ON and OFF.

- “NB” appears when the function is ON.

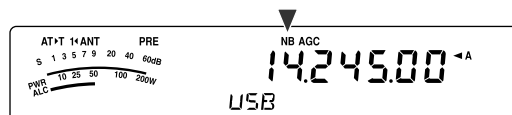

You can further adjust the Noise Blanker level from 1 to 10. The default level is 6.

Press **[NB/T/ 7] (1 s)**, then turn the **MULTI** control to adjust the Noise Blanker level.

- “NB LV.” and the current level appear on the sub-display.

Note:

- ◆ Noise Blanker is available only for SSB, CW, FSK, and AM modes.
- ◆ Increasing the Noise Blanker level degrades the intermodulation characteristics of the transceiver.

DIGITAL NOISE LIMITER (DNL)

Digital Noise Limiter (DNL) is designed to reduce pulse noise such as that generated by automobile ignitions. Try this function when the Noise Blanker function cannot remove the pulse noises effectively. Digital Noise Limiter does not function in FM mode.

Press **[DNL]** to toggle the DNL ON and OFF.

- “DNL” appears when the function is ON.

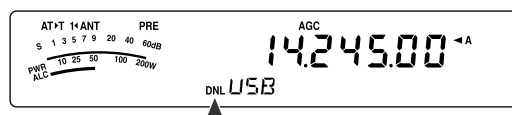

You can further adjust the DNL level from 1 to 3. The default level is 2.

Press **[DNL] (1 s)**, then turn the **MULTI** control to adjust the Digital Noise Limiter level.

- The current level appear on the sub-display.

Note:

- ◆ Digital Noise Limiter is available only for SSB, CW, FSK, and AM modes.
- ◆ Depending on a pulse type, the DNL function may not be able to remove the noise.
- ◆ Turning the DNL function ON when there is no pulse-type noise and the signal is relatively strong, it could degrade the signal readability.
- ◆ When the DNL function is ON, the high-cut filter frequency becomes 3.0 kHz regardless of the DSP filter settings.
- ◆ The DNL function can be used with the Beat Cancel (BC), Noise Reduction (NR), and Noise Blanker functions at the same time.

10 REJECTING INTERFERENCE

DSP FILTER FOR DATA COMMUNICATION (SSB/ FM)

The DSP filter for Data Communication is designed to improve the reception tone readability, especially for PSK31 and other new digital modes.

- 1 Press **[MENU/ F.LOCK]** and turn the **MULTI** control to select Menu No. 45.
- 2 Press **[v]/ [^]** to select “off” or “on” (default is OFF).

While Menu No. 45 is ON:

- 1 Press **[FIL/ NAR]**.
 - “WDH -- nnnn” (where “nnnn” is DSP filter bandwidth in Hz) appears.
- 2 Turn **MULTI** control to select the desired bandwidth.
- 3 Press **[FIL/ NAR]**.
 - “CTR -- nnnn” (where “nnnn” is a center filter frequency in Hz) appears.
- 4 Turn **MULTI** control to select the desired center frequency for the filter.
- 5 Press **[FIL/ NAR]** to complete the settings.

The following center frequencies and bandwidth combinations are available.

1000/ 1500 Hz is used for the PSK31 operation and 2210 Hz is used for the RTTY operation.

Center Freq. (Hz)	Filter bandwidth (Hz)						
1000	50	100	250	500	1000	1500	2400
1500	50	100	250	500	1000	1500	2400
2210	50	100	250	500	1000	1500	2400

Note: While Menu No. 45 is ON, the DSP filter bandwidth (page 46) cannot be changed.

DSP RX MONITOR

The DSP RX Monitor function temporarily cancels IF filter selection and DSP filter settings so that you can confirm the conditions of current reception frequency nearby.

To use the DSP RX Monitor function, first assign the PF key on the panel (or Mic PF keys) (page 64).

- 1 Press **[MENU/ F.LOCK]** and turn the **MULTI** control to select Menu No. 48.
- 2 Press **[v]/ [^]** to select “64”.
- 3 Press **[MENU/ F.LOCK]** to store the setting and exit the Menu mode.
- 4 Press **[PF]**.
 - While pressing **[PF]**, the transceiver cancels IF filter selection and DSP filter settings to its default values. When you release **[PF]**, the transceiver recovers the IF and DSP filter settings.

PRE-AMPLIFIER

Switching the pre-amplifier OFF may help reduce interference from adjacent frequencies.

Press **[ATT/PRE/ ANT1/2]** to cycle through “ATT” → “PRE” → “ ” (OFF) then return to “ATT”. Select “PRE” to turn the pre-amplifier ON. When it is ON, the signal is amplified approximately 12 dB.

- “PRE” appears when the function is ON.

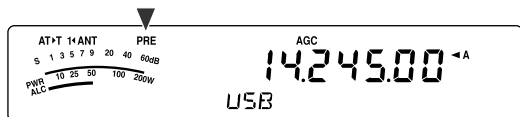

The ON/ OFF setting will be automatically stored in the current band. Each time you select the same band, the same setting will be automatically selected.

The frequency range of each band is provided in the table under “ATTENUATOR”.

ATTENUATOR

The Attenuator reduces the level of received signals. This function is useful when there is strong interference from adjacent frequencies.

Press **[ATT/PRE/ ANT1/2]** to cycle through “ATT” → “PRE” → “ ” (OFF) then return to “ATT”. Select “ATT” to activate the attenuator function. When it is ON, the signal is attenuated approximately 12 dB.

- “ATT” appears when the function is ON.

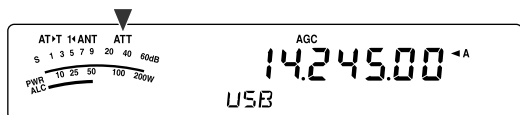

The ON/ OFF setting will be automatically stored in the current band. Each time you select the same frequency band, the attenuator setting will be automatically recalled.

The frequency range of each band is shown below.

Frequency Bands (MHz)	Pre-amplifier (Default)	Attenuator (Default)
0.03 ~ 2.5	OFF	OFF
2.5 ~ 4.1	OFF	OFF
4.1 ~ 6.9	OFF	OFF
6.9 ~ 7.5	OFF	OFF
7.5 ~ 10.5	ON	OFF
10.5 ~ 14.5	ON	OFF
14.5 ~ 18.5	ON	OFF
18.5 ~ 21.5	ON	OFF
21.5 ~ 25.5	ON	OFF
25.5 ~ 30.0	ON	OFF
30.0 ~ 60.0	ON	OFF

CW REVERSE (RECEPTION)

This function pivots the BFO from the default position (USB) to another position (LSB) in CW mode. It is sometimes effective to remove the interfering signals from the IF passband by pivoting the BFO.

- 1 Press **[MODE]** until “CW” appears.
- 2 Press **[MODE] (1 s)**.
 - “CW” changes to “CWR”.
- 3 To recover the default BFO position, press **[MODE] (1 s)** again.
 - “CWR” changes to “CW”.

MEMORY FEATURES

MEMORY CHANNELS

The transceiver provides you with 100 memory channels, numbered 00 to 99, for storing operating frequency data, modes and other information. Memory channels 00 to 89 are called Conventional Memory Channels. Memory channels 90 to 99 are designed for programming VFO tuning ranges and scan ranges. The data you can store is listed below.

Conventional memory channels are used for storing data you will often recall. For example, you may store the frequency where you regularly meet your club members.

Parameter	Channel 00 ~ 89	Channel 90 ~ 99
RX frequency	Yes	Yes ¹ (simplex)
TX frequency	Yes	
RX mode	Yes	Yes ¹ (simplex)
TX mode	Yes	
Programmable VFO Start/ End frequencies	No	Yes
RX frequency step size	Yes	Yes (simplex)
TX frequency step size	Yes	
Tone frequency	Yes	Yes
CTCSS frequency	Yes	Yes
Tone/ CTCSS ON/ OFF status	Yes	Yes
Memory name	Yes	Yes
Memory Channel Lockout ON/ OFF	Yes ¹	Yes ¹

¹ Changing the data after recalling a memory channel overwrites the contents of the channel.

STORING DATA IN MEMORY

There are 2 methods used for storing transmission/reception frequencies and associated data in memory channels 00 to 89. Use either method, depending on the relationship of the reception and transmission frequencies you store:

- Simplex channels:
RX frequency = TX frequency
- Split-frequency channels:
RX frequency ≠ TX frequency

Memory channels 90 to 99 can also be used as simplex channels.

Note: When RIT or XIT is ON, the frequency that includes the RIT or XIT offset will be stored.

■ Simplex Channels

- 1 Press **[A/B / M/V]** to select VFO A or VFO B.
 - “◀A” or “◀B” appears to show which VFO is selected.
- 2 Select the frequency, mode, etc. to be stored.
- 3 Press **[QMI/ M.IN] (1 s)** to enter Memory Scroll mode.
 - “M.SCR” appears.



- To exit Memory Scroll mode and abort the storage process, press **[MTR/ CLR]**.
- 4 Turn the **MULTI** control, or press Mic **[UP]/ [DWN]** to select a memory channel.
 - You can also select a channel by entering a 2-digit number, such as 12, using the numeric keys. Press **[1], [2]** for example.

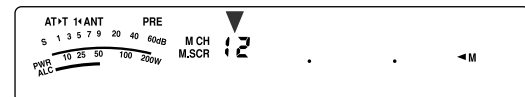

- 5 Press **[QMI/ M.IN]** again to store the data.
 - The previous data stored in the channel is overwritten.

■ Split-Frequency Channels

- 1 Press **[A/B / M/V]** to select VFO A or VFO B.
 - “◀A” or “◀B” appears to show which VFO is selected.
- 2 Select the frequency, mode, etc. to be stored.
 - This frequency and mode will be used for transmitting.
- 3 Press **[A/B / M/V]** to select the other VFO.
- 4 Select the reception frequency and mode.
- 5 Press **[A=B/ SPLIT] (1 s)**.
 - “**SPLIT**” appears.

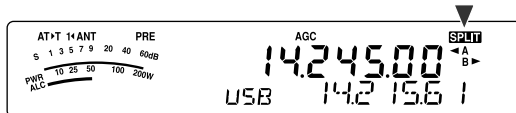

- 6 Press **[QMI/ M.IN] (1 s)** to enter Memory Scroll mode.

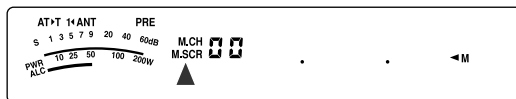

- To exit Memory Scroll mode and abort the storage process, press **[MTR/ CLR]**.
- 7 Turn the **MULTI** control, or press Mic **[UP]/ [DWN]** to select a memory channel.
 - You can also select a channel by entering a 2-digit number, such as 12, using the numeric keys. Press **[1]**, **[2]** for example.

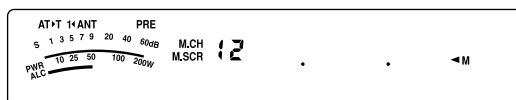

- 8 Press **[QMI/ M.IN]** to store the data.
 - The previous data stored in the channel is overwritten.

Note: When subtone frequencies differ between TX and RX while performing memory-VFO split operation, the subtone frequency for TX will be stored in the memory channel.

MEMORY RECALL AND SCROLL

There are 2 modes which allow you to retrieve frequencies and associated data that you stored in a memory channel: Memory Recall and Memory Scroll.

Memory Recall:

In this mode, the transceiver receives and transmits using a frequency that you retrieve. You can temporarily change the frequency and associated data without overwriting the contents of the memory channel when Menu No. 07 is ON (default is OFF).

Memory Scroll:

Use this mode to check the contents of the memory channels without changing the current reception frequency. In this mode, frequencies you retrieve are not used for receiving and transmitting.

■ Memory Recall

- 1 Press **[A/B / M/V] (1 s)** to enter Memory Recall mode.
 - The memory channel that was last selected appears.



- 2 Turn the **MULTI** control, or press Mic **[UP]/ [DWN]** to select a memory channel.
 - Continuously holding down Mic **[UP]/ [DWN]** steps the transceiver through the memory channels until the key is released.
 - Memory channels which contain no data are skipped.
 - You cannot change memory channels while transmitting.
- 3 To exit Memory Recall mode, press **[A/B / M/V] (1 s)**.

Note: If Menu No. 07 is selected “on”, the frequency of the split-memory channel can be changed while using the TF-SET function.

11 MEMORY FEATURES

Memory Scroll

- Press **[QMI/ M.IN]** (1 s) to enter Memory Scroll mode.
 - The memory channel that was last selected appears.

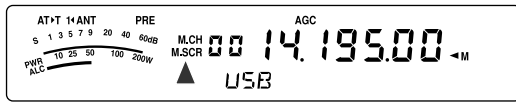

- Turn the **MULTI** control, or press Mic **[UP]/ [DWN]** to step through the memory channels.
 - You can also change channels by entering a 2-digit number. Press **[8]**, **[9]** for example.
- To exit Memory Scroll mode, press **[MTR/ CLR]**.
 - The transceiver re-displays the memory channel or VFO frequency that was selected before you activated Memory Scroll.

Note:

- While the transceiver is in Memory Scroll mode, you can operate the following controls and keys only: **[QMI/ M.IN]**, **[MTR/ CLR]**, numeric keys (**[0]** ~ **[9]**), Mic **[UP]/ [DWN]**, Mic **[PTT]**, **AF** control, **SQL** control, **MULTI** control and **[ϕ]** (**POWER**).
- Do not press **[QMI/ M.IN]** again after entering Memory Scroll mode. Pressing **[QMI/ M.IN]** results in over-writing the current VFO data to the memory channel you selected.

Temporary Frequency Changes

After retrieving frequencies and associated data in Memory Recall mode, you can temporarily change the data without overwriting the contents of the memory channel.

- Access Menu No. 07 and select “on”.
 - Skip this step when changing only the associated data (not the frequency).
- Recall a memory channel.
- Change the frequencies and associated data.
 - Use only the **Tuning** control to select a frequency.
- If necessary for future use, store the changed data in another memory channel. Refer to “Channel ⇒ Channel Transfer” {below}.

Note: If Menu No. 07 is selected “on”, the frequency of the split-memory channel can be changed while using the **TF-SET** function.

MEMORY TRANSFER

Memory ⇒ VFO Transfer

After retrieving frequencies and associated data from Memory Recall mode, you can copy the data to the VFO. This function is useful, for example, when the frequency you want to monitor is near the frequency stored in a memory channel.

- Recall the desired memory channel {page 51}.
- Press **[QMR/ M▶ VFO]** (1 s).
 - When a simplex channel is recalled, the data is copied to VFO A or VFO B, depending on which VFO was used to recall the channel.
 - When a split channel is recalled, the RX data is copied to VFO A and the TX data is copied to VFO B.

Note: Pressing **[QMR/ M▶ VFO]** (1 s) after temporarily changing the retrieved data copies the new data to the VFO.

Channel ⇒ Channel Transfer

You can also copy channel information from one memory channel to another. This function is useful when storing frequencies and associated data that you temporarily change in Memory Recall mode.

- Recall the desired memory channel {page 51}.
- Press **[QMI/ M.IN]** to enter Memory Scroll mode.
 - To exit Memory Scroll mode, press **[MTR/ CLR]**.
- Select the memory channel where you would like the data copied, using the **MULTI** control.
- Press **[QMI/ M.IN]** (1 s).

Channel 00 ~ 89	⇒	Channel 00 ~ 89
RX frequency	⇒	RX frequency
TX frequency	⇒	TX frequency
Mode for RX	⇒	Mode for RX
Mode for TX	⇒	Mode for TX
RX frequency step	⇒	RX frequency step
TX frequency step	⇒	TX frequency step
Tone frequency	⇒	Tone frequency
CTCSS frequency	⇒	CTCSS frequency
Tone/ CTCSS ON/ OFF status	⇒	Tone/ CTCSS ON/ OFF status
Memory Name	⇒	Memory Name
Memory Channel Lockout ON/ OFF	⇒	Memory Channel Lockout OFF

Channel 00 ~ 89	➔	Channel 90 ~ 99
RX frequency	➔	TX/ RX frequency (simplex)
TX frequency	➔	
Mode for RX	➔	Mode for TX/ RX (simplex)
Mode for TX	➔	
RX frequency step	➔	TX/ RX frequency step (simplex)
TX frequency step	➔	
Tone frequency	➔	Tone frequency
CTCSS frequency	➔	CTCSS frequency
Tone/ CTCSS ON/ OFF status	➔	Tone/ CTCSS ON/ OFF status
Memory Name	➔	Memory Name
Memory Channel Lockout ON/ OFF	➔	Memory Channel Lockout OFF

Channel 90 ~ 99	➔	Channel 00 ~ 89
TX/ RX frequency	➔	RX frequency
	➔	TX frequency
Mode for TX/ RX	➔	Mode for RX
	➔	Mode for TX
TX/ RX frequency step (simplex)	➔	RX frequency step
	➔	TX frequency step
Tone frequency	➔	Tone frequency
CTCSS frequency	➔	CTCSS frequency
Tone/ CTCSS ON/ OFF status	➔	Tone/ CTCSS ON/ OFF status
Memory Name	➔	Memory Name
Memory Channel Lockout ON/ OFF	➔	Memory Channel Lockout OFF

When copying a memory channel 90 ~ 99 ➔ channel 90 ~ 99, Memory Channel Lockout status changes to OFF, regardless of the original channel settings.

The tables above illustrate how data is transferred between memory channels.

STORING FREQUENCY RANGES

Memory channels 90 to 99 allow you to store frequency ranges for VFO tuning and Program Scan. Program Scan is described in the next chapter. To tune or scan frequencies within a specified range, store the start and end frequencies for that range in advance.

- 1 Press **[A/B / M/V]** to select VFO A or VFO B.
- 2 Select the desired start frequency.
- 3 Press **[QMI/ M.IN]** (1 s) to enter Memory Scroll mode.
 - To exit Memory Scroll mode and abort the storage process, press **[MTR/ CLR]**.
- 4 Turn the **MULTI** control, or press Mic **[UP]/ [DWN]** to select a memory channel in the range of 90 to 99.

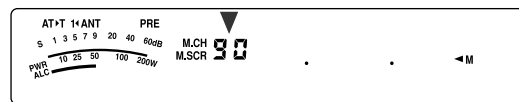

- You can also select a channel by entering a 2-digit number. Press **[9]**, **[0]** for example.
- 5 Press **[QMI/ M.IN]** to store the start frequency in the memory channel.
 - “ENDINPUT” appears on the sub-display.

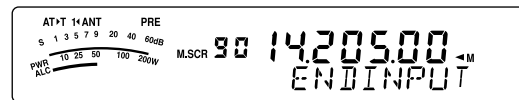

- 6 Turn the **Tuning** control or **MULTI** control to select the end frequency.
- 7 Press **[QMI/ M.IN]** to store the end frequency in the memory channel.
 - The previous data stored in the channel is overwritten.

■ Confirming Start/ End Frequencies

Use this procedure to check the start and end frequencies that you stored in channels 90 to 99.

- 1 Press **[A/B / M/V]** (1 s) to enter Memory Recall mode.
- 2 Turn the **MULTI** control, or press Mic **[UP]/ [DWN]** to select a memory channel from 90 to 99.
- 3 Press **[v]** to check the start frequency and **[^]** to check the end frequency.

11 MEMORY FEATURES

■ Programmable VFO

Using the start and end frequencies that you stored in channels 90 to 99, Programmable VFO restricts the frequency range that you can tune with the **Tuning** control. One application of this function is to help you operate within the authorized frequency limits of your license.

- 1 Press **[A/B / M/V]** (1 s) to enter Memory Recall mode.
- 2 Turn the **MULTI** control, or press Mic **[UP]/ [DWN]** to select a memory channel from 90 to 99.
 - You can also select a channel by entering a 2-digit number. Press **[ENT]**, **[9]**, **[0]** for example.

Now you can only tune from the start frequency to the end frequency, using the **Tuning** control.

Note: Pressing Mic **[UP]/[DWN]** or turning the **MULTI** control changes the memory channel number while in Programmable VFO mode.

MEMORY CHANNEL LOCKOUT

You can lock out memory channels that you prefer not to monitor during Memory Scan. Memory Scan is described in the next chapter {page 58}.

- 1 Press **[A/B / M/V]** (1 s) to enter Memory Recall mode.
- 2 Turn the **MULTI** control, or press Mic **[UP]/ [DWN]** to select the desired memory channel.
 - You can also select a channel by entering a 2-digit number. Press **[ENT]**, **[3]**, **[4]** for example.
- 3 Press **[ENT]** (1 s).
 - A dot appears beside the right-most digit of the memory channel number to indicate the channel has been locked out.

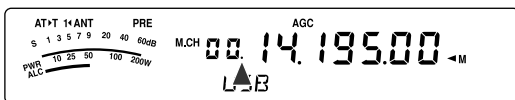

- Pressing **[ENT]** (1 s) toggles between adding and removing the channel from the scan list.

ERASING MEMORY CHANNELS

If there are memory channels that you will not recall in the future, you may prefer erasing the contents of those channels.

- 1 Press **[A/B / M/V]** to enter Memory Recall mode.
- 2 Turn the **MULTI** control, or press Mic **[UP]/ [DWN]** to select the desired memory channel.
 - You can also select a channel by entering a 2-digit number. Press **[ENT]**, **[3]**, **[4]** for example.
- 3 Press **[MTR/ CLR]** (1 s).
 - A long beep sounds to confirm that the channel data has been erased.

MEMORY CHANNEL NAME

You can assign a name to each memory channel. A maximum of 8 alpha-numeric characters can be stored.

- 1 Press **[A/B / M/V]** (1 s) to enter Memory Recall mode.
- 2 Turn the **MULTI** control, or press Mic **[UP]/ [DWN]** to select a memory channel.
- 3 Press **[QMR/ M▶ VFO]**.

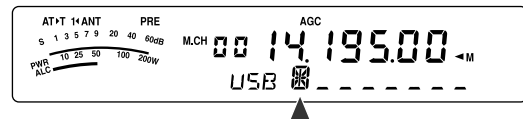

- 4 Turn the **MULTI** control to select the desired alpha-numeric character. You can move the cursor to the left by pressing **[<]**, or to the right by pressing **[>]**. Press **[CL]** to erase the character at the cursor.

Note: You cannot name the Quick Memory channels.

- 5 After selecting all the necessary characters for the memory channel name, press **[QMR/ M▶ VFO]** to store the name.
- 6 When you recall a memory channel with a name, the name is displayed on the sub-display along with the memory channel number {page 51}.

Available alpha-numeric characters

A	B	C	D	E	F	G	H	I	J	K	L	M	N
O	P	Q	R	S	T	U	V	W	X	Y	Z	SP	*
+	-	/	0	1	2	3	4	5	6	7	8	9	

“SP” represents a space character.

QUICK MEMORY

Quick Memory is designed to quickly and temporarily save data without specifying a particular memory channel. Use Quick Memory to store data you will not use in future operating sessions. For example, as you tune across the band looking for DX, it is convenient to store stations that you want to contact. You can quickly jump between several different memory channels as you monitor them.

This transceiver provides 10 Quick Memory channels ("0_" to "9_") that can store the following data:

VFO A frequency and operating mode	VFO B frequency and operating mode
RIT ON/ OFF	XIT ON/ OFF
RIT/ XIT offset frequency	DSP filter bandwidth
Noise Blanker ON/ OFF	FINE ON/ OFF
DSP Noise Reduction OFF/ 1/ 2	DSP Beat Cancel OFF/ 1/ 2
Digital Noise Limiter OFF/ 1 ~ 3	TX/ RX functions

STORING INTO QUICK MEMORY

Each time you store a new frequency, all previously stored frequencies are bumped to the next respective Quick Memory channel. When all 10 memory channels contain frequencies, storing one more frequency bumps the contents of memory channel 9 off the stack (the data is lost).

The following diagram illustrates how the Quick Memory stacks the data in memory each time you press [QMI/ M.IN].

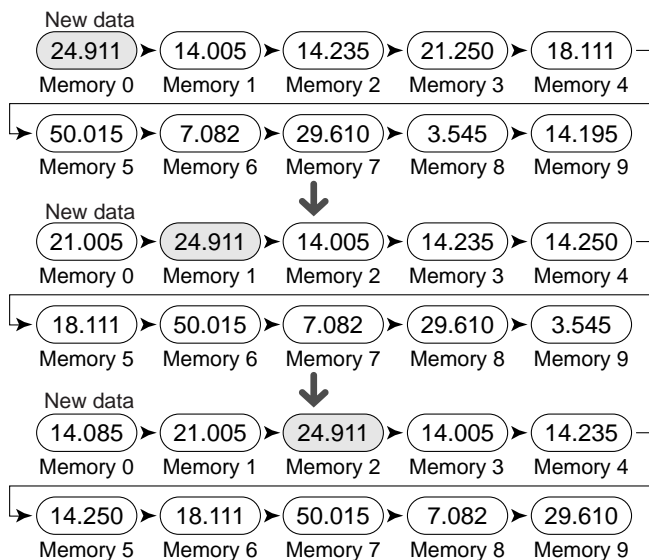

You can store data in the Quick Memory only when you operate the transceiver in VFO mode.

- 1 Select the frequency, mode, etc. on the transceiver VFO.
- 2 Press [QMI/ M.IN].

- Each time [QMI/ M.IN] is pressed, the current VFO data is written to the Quick Memory.

Note: When RIT or XIT is ON, this ON status and the offset will also be stored.

RECALLING QUICK MEMORY CHANNELS

You can recall a Quick Memory channel only when you operate the transceiver in VFO mode.

- 1 Press [QMR/ M▶ VFO].
 - The current memory channel number appears.



- If there is no data stored in any Quick Memory channel, the data cannot be recalled to the current VFO, an error beep sounds.
- 2 Turn the **MULTI** control to select a Quick Memory channel (0 to 9).
 - You cannot change memory channels while transmitting.
 - 3 To exit, press [QMR/ M▶ VFO] again.

Note: Memory channels cannot be changed while using the TF-SET function.

TEMPORARILY FREQUENCY CHANGES

After recalling a Quick Memory channel, you can temporarily change the data without overwriting the contents of the channel. You can change the frequency even when you select "OFF" in Menu No. 07.

- 1 Press [QMR/ M▶ VFO].
- 2 Turn the **MULTI** control to select a Quick Memory channel (0_ to 9_).
- 3 Change the frequencies and associated data.
- 4 To store the changed data in the Quick Memory, press [QMI/ M.IN].
 - This action stores the new data in the current channel and bumps the old frequency to the next higher Quick Memory channel.
- 5 To exit, press [QMR/ M▶ VFO] again.

Note: Memory channel data can also be changed while using the TF-SET function.

QUICK MEMORY ⇒ VFO TRANSFER

This function copies the contents of the recalled memory channel to the VFO.

- 1 Recall a Quick Memory channel.
- 2 Press [QMR/ M▶ VFO] (1 s).

Note: Pressing [QMR/ M▶ VFO] after temporarily changing the recalled data copies the new data to the VFO.

Scan is a useful function for hands-off monitoring of your favorite frequencies. By becoming comfortable with all types of Scan, you will increase your operating efficiency.

This transceiver provides the following types of scans.

Scan Type		Purpose
Normal Scan	VFO Scan	Scans the entire frequency range of the transceiver.
	Program Scan	Scans the specific frequency ranges stored in Memory channels 90 ~ 99.
Memory Scan	All-Channel Scan	Scans all Memory channels, from 00 to 99.
	Group Scan	Scans the specific Memory channel groups.

Note:

- ◆ While using CTCSS in FM mode, Scan stops only for the signals that contain the same CTCSS tone that you selected.
- ◆ Pressing Mic [PTT] causes Scan to stop.

NORMAL SCAN

When you are operating the transceiver in VFO mode, 2 types of scanning are available.

- VFO Scan

The transceiver scans the entire frequency range of the transceiver. For example, if you are operating and receiving on the transceiver's VFO A at 14.195.00 MHz, it scans entire frequencies in the range of 30.00 kHz to 59.999.99 MHz. (Refer to available VFO frequency range in the Specifications.)

- Program Scan

By programming the start and end frequency in Memory channels 90 ~ 99 {page 53}, you can limit the scanning frequency range. Since there are 10 memory channels (90 ~ 99) available for specifying the start and end frequency, you can select one or more (a maximum of 10) ranges to scan. This is useful when you are waiting for a DX station on a certain frequency but the station may appear on a slightly higher or lower frequency.

VFO SCAN

VFO Scan scans the entire frequency range that is available for the current VFO. When the Program Scan frequency range is not programmed or no Scan Group is selected for the Program Scan, the transceiver also scans the entire frequency range available for the current VFO.

The memory channel numbers 90 ~ 99 have alias names, "VGROUP". "VGROUP-0" represents channel 90, "VGROUP-1" represents channel 91, "VGROUP-2" represents channel 92, and so on up to "VGROUP-9" which represents channel 99.

If one or more Program Scan frequency ranges are programmed in VGROUP-0 to 9 (Memory channel numbers 90 ~ 99 in other words):

- 1 Press **[SCAN/ SG.SEL] (1 s)** in VFO mode.
 - "VGROUP -- n" (where n represents a VGROUP number from 0 to 9) appears on the sub-display.
- 2 Turn the **MULTI** control to select the Program Scan memory (VGROUP-0 to VGROUP-9). As you select the channel, "on" or "oFF" appears on the frequency display. "on" signifies that the selected VGROUP is active for the Program Scan and "oFF" signifies that the selected VGROUP is inactive for the Program Scan.

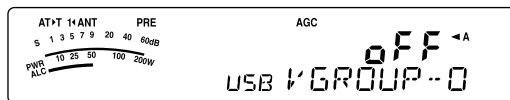

Configure all VGROUP channels (VGROUP-0 ~ VGROUP-9) as "oFF" by pressing [V].

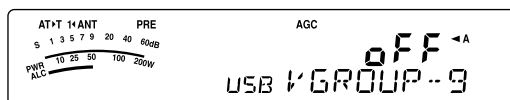

- 3 Press **[SCAN/ SG.SEL]** or **[MTR/ CLR]** to return to the current VFO mode.
- 4 Press **[SCAN/ SG.SEL]** to start the VFO Scan.
- 5 Press **[SCAN/ SG.SEL]** or **[MTR/ CLR]** to stop the VFO Scan.

Note:

- ◆ While scanning, you can change the scan speed by turning the **RIT/ XIT** control. Turn the control clockwise/ counterclockwise to decrease/ increase the scan speed. The speed indicator appears on the sub-display, where P1 is the fastest speed and P9 is the slowest.
- ◆ You cannot change the VFO Scan speed in FM mode.

PROGRAMSCAN

Program Scan monitors the range between the start and end frequencies that you have stored in Memory channels 90 ~ 99 (VGROUP-0 ~ 9). Refer to "STORING FREQUENCY RANGES" {page 53} for details on how to store the start and end frequencies to Memory channels 90 ~ 99 (VGROUP-0 ~ 9).

You can select a maximum of 10 memory channels (VGROUP 0 to 9) and sequentially scan the frequency ranges that you stored in these channels. If the current VFO frequency falls within the selected VGROUP frequency range, the Program Scan starts from the VGROUP number and then continues to scan the next larger VGROUP number. If the current VFO frequency is outside all of the VGROUP frequency ranges, the Program Scan starts from the smallest VGROUP number that is selected as "on" (each VGROUP can be set to either "on" or "oFF").

- 1 Press **[A/B / M/V]** to select VFO A or VFO B.
- 2 Press **[SCAN/ SG.SEL] (1 s)**.

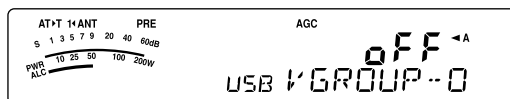

- 3 Turn the **MULTI** control or press Mic **[UP]/ [DWN]** to select the memory channel (VGROUP-0 to

VGROU—9). As you select the Memory Channel, “on” or “oFF” appears on the main frequency display. “on” signifies that the memory channel is active for the Program Scan and “oFF” signifies that the memory channel group is inactive for the Program Scan.

- To activate the Program Scan frequency range, select the desired VGROU number by turning the **MULTI** control. Then, press [**^**] to select “on” for the VGROU (channel). When a channel is activated for the Program Scan, “on” appears on the display.

Note: At least one of the valid Program Scan channels (from 90 to 99) must be programmed and selected to perform the Program Scan. If no VGROU (memory channel 90 ~ 99) is selected for the Program Scan, the transceiver performs the VFO Scan (above).

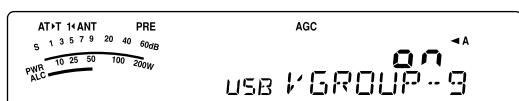

- Press [**SCAN/ SG.SEL**] or [**MTR/ CLR**] to return to the current VFO mode.
- Press [**SCAN/ SG.SEL**] to start the Program Scan.
 - To quickly move towards a desired frequency while scanning, turn the **Tuning** control or the **MULTI** control, or press Mic [**UP**]/ [**DWN**].
 - Turning the **RIT/ XIT** control clockwise decreases the scan speed and counterclockwise increases the speed, except while in FM mode. The current scan speed is shown on the display; P1 is the fastest speed and P9 is the slowest.
 - While in FM mode, Scan automatically stops on a frequency where a signal is present. The transceiver will either remain on that channel for a short time (Time-Operated mode) or until the signal drops out (Carrier-Operated mode), depending on which mode you select via Menu No. 11 {page 58}.
- To stop Scan, press [**SCAN/ SG.SEL**] or [**MTR/ CLR**].

Note:

- If you have turned the **SQL** control clockwise, far beyond the squelch threshold while in FM mode, Scan may fail to stop at a channel where a signal is present. If this happens, turn the **SQL** control slightly counterclockwise.
- If you press [**SCAN/ SG.SEL**] before storing any frequency range for memory channels 90 to 99, the transceiver starts VFO scan.
- When the current receive frequency is within one of the ranges that you selected with channel numbers, Scan starts with the current frequency. The operating mode stored in the memory channel is used.
- The operating mode can be changed while scanning, but the memory channel is overwritten with the changed mode.
- When the current Scan range is smaller than a single step of the **MULTI** control, turning the control clockwise causes Scan to jump to the start frequency, and counterclockwise to the end frequency.
- Starting Program Scan switches OFF the RIT and XIT functions.
- While in FM mode, the Program Scan monitors rounded off frequencies regardless of the Menu No. 05 setting.

PROGRAMSCANPARTIALLYSLOWED

You can specify a maximum of 5 frequency points for each memory channel from 90 to 99 so that the Program Scan slows down the scanning speed. To specify the slow down frequency points, first program the start and end frequencies into a memory channel (90 ~ 99) {page 53}.

- Access Menu No. 08 to confirm that the function is ON (default is ON).
- You can further configure the slow down frequency width. Access Menu No. 09 to select the range from 100 Hz to 500 Hz (default is 300 Hz).

Note: If you select, for example, 500 Hz for Menu No. 09, the Program Scan slows down to a ± 500 Hz width, centering the frequency you marked below.

- Press [**A/B / M/V**] (1 s) and turn the **MULTI** control to recall the memory channel (90 ~ 99) for which you want to specify the scan slow down frequencies.
- Press [**∨**]/ [**^**] to confirm the start ([**∨**]) or end ([**^**]) frequency.
- Turn the **Tuning** control to the center frequency point that you want the Program Scan to slow down. Press [**QMI/ M.IN**] to mark the slow down frequency point. The “**⊠**” icon appears.
- Repeat step 5 to specify the center slow down frequency points. You can specify a maximum of 5 frequency points for each channel.
- If you want to clear a slow down frequency point that you previously stored, select the frequency that you stored. Press [**QMI/ M.IN**] at this frequency spot where “**⊠**” appears.
 - A confirmation beep sounds and the transceiver “**⊠**” disappears.
 - If you want to clear all the slow down frequency points at once, perform the Channel **→** Channel Transfer to overwrite the memory data to the same memory channel {page 52}. This operation removes all the frequency points that you stored.
- Press [**A/B / M/V**] to return to VFO mode.

- Press [**SCAN/ SG.SEL**] to start the Program Scan with the slow down frequency point(s).

Note:

- During the Program Scan, you can turn the **RIT/ XIT** control to adjust the scanning speed. Turn the control clockwise/ counterclockwise to slow down/ speed up the scan. The Program Scan speed indicator appears on the main dot-matrix display during the Program Scan; P1 is the fastest speed and P9 is the slowest.
- You cannot change the Program Scan speed in FM mode.
- You can specify the Program Scan slow down frequency point in FM mode but it does not function.

SCANHOLD

This function stops Program Scan for approximately 5 seconds, then resumes Scan when you jump to the desired frequency by turning the **Tuning** control or the **MULTI** control, or by pressing Mic [**UP**]/ [**DWN**].

To use this function, access Menu No. 10, and select “on”. The default is OFF.

MEMORY SCAN

Memory Scan monitors all memory channels in which you have stored frequencies (All-channel Scan) or only a desired group of memory channels (Group Scan).

Scan automatically stops at a channel where a signal is present, regardless of the operating mode. The transceiver will either remain on that channel for a short time (Time-Operated mode) or until the signal drops out (Carrier-Operated mode). Use Menu No. 11 to select the mode. The default is “to” (Time-Operated).

SCAN RESUME METHOD

The transceiver stops scanning at the frequency (or memory channel) where a signal is detected. It then continues scanning according to which resume mode you have selected. You can choose one of the following modes. The default is Time-operated mode.

- **Time-Operated mode (“to”)**

The transceiver remains on a busy frequency (or memory channel) for approximately 6 seconds, then continues to scan, even if the signal is still present.

- **Carrier-Operated mode (“co”)**

The transceiver remains on the busy frequency (or memory channel) until the signal drops out. There is a 2 second delay between signal dropout and scan resumption.

- 1 Press **[MENU/ F.LOCK]** to enter Menu mode.
- 2 Turn the **MULTI** control to select Menu No. 11.
- 3 Press **[v]/ [^]** to select “to” (Time-Operated) or “co” (Carrier-Operated).

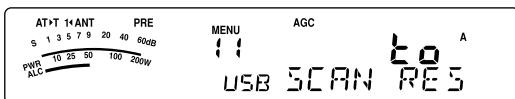

- 4 Press **[MENU/ F.LOCK]** to complete the setting and exit Menu mode.

You can lock out the memory channels that you prefer not to monitor while scanning. To do this, refer to “Memory Channel Lockout” {page 54}.

ALGORITHM SCAN

Use the following procedure to scan all the memory channels that contain frequency data in sequence, ignoring the Memory Group number.

- 1 Select Time-operated or Carrier-operated mode via Menu No. 11.
- 2 Press **[A/B / M/V] (1 s)** to enter Memory Recall mode.
- 3 Turn the **SQL** control to adjust the squelch threshold to mute the speaker.
- 4 Press **[SCAN/ SG.SEL] (1 s)** to enter Scan Group Select mode.
 - Turn the **MULTI** control to select the Memory channel group.
 - MGROUP–0 represents Memory channel 0 ~ 9, MGROUP–1 represents Memory channel 10 ~ 19 and so on up to MGROUP–9 which represents Memory channel 90 ~ 99 {page 53}.
- 5 As you select the Memory Groups using the **MULTI** control, press **[v]** to select “oFF” for all Memory Groups.
- 6 Press **[SCAN/ SG.SEL]** to return to Memory Recall mode.
- 7 Press **[SCAN/ SG.SEL]** to start All-channel Scan.
 - Scan starts from the current memory channel and ascends up through the channel numbers. (The scan direction cannot be changed.)
 - To jump to a desired channel while scanning, turn the **MULTI** control, or press Mic **[UP]/ [DWN]**.
- 8 To stop Scan, press **[SCAN/ SG.SEL]** or **[MTR/ CLR]**.

Note:

- ◆ If you have turned the **SQL** control clockwise, far beyond the squelch threshold, Scan may fail to stop at a channel where a signal is present. If this happens, turn the **SQL** control slightly counterclockwise.
- ◆ Starting Memory Scan switches OFF the RIT and XIT functions.

GROUPSCAN

100 memory channels are divided into 10 groups so that you can select one or more groups to be scanned, depending on the situation.

■ Memory Group

When you store frequency data in a memory channel {page 50}, the memory channel belongs to one of 10 groups as shown below.

Memory Channel No.	Memory Group No.	Memory Channel No.	Memory Group No.
0 ~ 9	MGROUP-0	50 ~ 59	MGROUP-5
10 ~ 19	MGROUP-1	60 ~ 69	MGROUP-6
20 ~ 29	MGROUP-2	70 ~ 79	MGROUP-7
30 ~ 39	MGROUP-3	80 ~ 89	MGROUP-8
40 ~ 49	MGROUP-4	90 ~ 99	MGROUP-9

■ Scan Group Select

You can select one or more groups to be scanned. First, select the groups to be scanned.

- 1 Press **[A/B / M/V] (1 s)** to enter Memory Recall mode.
 - "M.CH" appears.
- 2 Press **[SCAN/ SG.SEL] (1 s)** to enter Scan Group Select mode.
- 3 As you turn the **MULTI** control, the MGROUP number on the sub-display changes.
 - MGROUP-0 represents Memory channel 0 ~ 9, MGROUP-1 represents Memory channel 10 ~ 19 and so on up to MGROUP-9 which represents Memory channel 90 ~ 99.
- 4 Press **[^]** to select "on" to add the group to the Group Scan list.
 - If you do not wish the selected Group to be scanned, press **[v]** to select "oFF".
- 5 Press **[SCAN/ SG.SEL]** to exit the Scan Group Select mode.

■ Performing Group Scan

Group Scan starts with the smallest group number and repeats the sequence. For example, if you selected "on" for MGROUP-3, MGROUP-5, and MGROUP-7, the transceiver scans the channels in MGROUP-3 → MGROUP-5 → MGROUP-7 → MGROUP-3 and so on.

- 1 Select Time-operated or Carrier-Operated mode via Menu No. 11.
- 2 Press **[A/B / M/V] (1 s)** to enter Memory Recall mode.
- 3 Turn the **SQL** control to adjust the squelch threshold.
- 4 Press **[SCAN/ SG.SEL]** to start Memory Group Scan.
 - Scan ascends up through the channel numbers. (The scan direction cannot be changed.)
 - To jump to a desired channel while scanning, turn the **MULTI** control or press and hold Mic **[UP]/ [DWN]**.
- 5 To stop Scan, press **[SCAN/ SG.SEL]** or **[MTR/ CLR]**.

Note:

- ◆ If you have turned the **SQL** control clockwise, far beyond the squelch threshold, Scan may fail to stop at a channel in which a signal is present. If this happens, turn the **SQL** control slightly counterclockwise.
- ◆ When the current channel is within one of the groups that you selected, Scan starts with the current channel.
- ◆ When the current channel is outside all the groups that you selected, Scan starts with the group number that is larger than and closest to the group number of the current channel.
- ◆ Starting Memory Scan switches OFF the RIT and XIT functions.

OPERATOR CONVENIENCES

ANTENNAS

Two antenna connectors are available for the HF/50 MHz band on the TX/ RX unit rear panel {page 16}.

Press **[ATT/PRE/ ANT1/2]** (1 s) to select ANT 1 or ANT 2.

- “1◀ANT” or “ANT▶2” appears to indicate which antenna is selected.

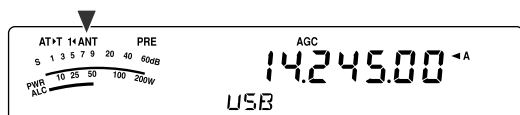

The ANT 1/ ANT 2 setting will automatically be stored in the antenna band memory. Next time you select the same band, the same antenna will be automatically selected.

Antenna Selection Frequency Range (MHz)	
0.03 ~ 2.5	2.5 ~ 4.1
4.1 ~ 6.9	6.9 ~ 7.5
7.5 ~ 10.5	10.5 ~ 14.5
14.5 ~ 18.5	18.5 ~ 21.5
21.5 ~ 25.5	25.5 ~ 30.0
30.0 ~ 60.0	

Note: Connect an external tuner to the ANT 1 connector only, then select ANT 1. The internal antenna tuner will be automatically bypassed when the transceiver is switched ON.

APO (Auto Power OFF)

You can set the transceiver to switch OFF automatically if no keys or controls are pressed or adjusted for a certain period of time. One minute before the transceiver switches OFF, “CHECK” is output in Morse code.

Press **[MENU/ F.LOCK]**, then turn the **MULTI** control to access Menu No. 59.

Select the APO time from “OFF”, “60”, “120”, or “180” minutes.

Note:

- ◆ The APO function works even if the transceiver is scanning.
- ◆ The APO timer starts counting down the timer when no key presses, no control adjustments, and no command (COM connector) sequences are detected.

AUTOMATIC ANTENNA TUNER

As explained in “ANTENNA CONNECTION” {pages 2, 4}, matching the impedance of the coaxial cable and antenna is important. To adjust the impedance between the antenna and the transceiver, you have the choice of using the internal antenna tuner (TS-480SAT only) or an external antenna tuner. This section describes how to use the internal antenna tuner. For the external antenna tuner, consult the instruction manual that comes with the tuner.

1 Select the transmit frequency.

2 Press **[ATT/PRE/ ANT1/2]** (1 s) to select “1◀ANT” or “ANT▶2”.

- If the external antenna tuner (AT-300) is connected to the ANT 1 connector, select ANT 2 to use the internal antenna tuner. The internal antenna tuner is automatically bypassed if the external antenna tuner (AT-300) is connected to ANT 1.

3 Press **[AT]** momentarily.

- “AT▶T” appears, indicating that the antenna tuner is in-line (not bypassed).

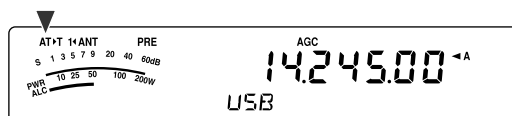

4 Press **[AT]** (1 s).

- CW mode is automatically selected and tuning begins.
- “AT▶T” blinks and the LED lights red.
- To cancel tuning, press **[AT]** again.
- If the SWR of the antenna system is extremely high (more than 10:1), an alarm (“SWR” in Morse code) sounds and the internal antenna tuner is bypassed. Before attempting to tune again, adjust the antenna system to lower the SWR.

5 Monitor the display and check that tuning has successfully finished.

- If the tuning was successful, “AT▶T” stops blinking and the red LED turns OFF.
- If tuning does not finish within approximately 20 seconds, an alarm (“5” in Morse code) sounds. Press **[AT]** to stop the alarm and tuning.
- If you want the transceiver to stay in transmission mode after the tuning completes, access Menu No. 25 and select “on”.

If you access Menu No. 26 and select “on”, received signals will also pass through the internal antenna tuner. When this function is ON, “R◀AT” appears. This may reduce interference on the receive frequency.

Note:

- ◆ The internal antenna tuner will not tune outside the available transmission frequency limits.
- ◆ Pressing **[AT]** for more than one second while transmitting, interrupts transmitting and starts tuning.
- ◆ While using CW Full Break-in, the internal antenna tuner will be in-line for both transmission and reception.
- ◆ Tuning automatically turns OFF in approximately 60 seconds. “AT” disappears and the error beeps stop.
- ◆ Tuning may still continue when the SWR meter indicates 1:1. This happens due to the tuning algorithm; this is not a malfunction.
- ◆ Even though the SWR meter shows more than one segment, the internal antenna tuner may not re-tune. This happens because of an SWR calculation algorithm tolerance.
- ◆ If tuning does not finish even though the SWR meter indicates smaller than 3:1, adjust the antenna system to lower the SWR, then attempt to tune again.
- ◆ Tuning may not reach an SWR of 1:1, depending on the transceiver conditions.

■ Presetting

After each successful tuning session, the AT Preset memory function stores the position of the tuning capacitor in the memory. The position of the capacitor is stored for each of the antenna tuner bands (see the following table) and for each antenna connector (ANT 1 and ANT 2).

Press [AT] momentarily.

- “AT▶T” will appear, showing that the antenna tuner is in-line (not bypassed).
- Each time you go across the antenna tuner band, the AT Preset memory is automatically recalled to position the tuning capacitor without the need for retuning. If no preset data exists for a particular band/ antenna combination, then the default data of 50 Ω is used.

Note: Tuning may restart in order to obtain the optimum matching condition even though the current antenna tuner band has the preset data.

AT Preset Frequency Range (MHz)	
0.03 ~ 1.85	1.85 ~ 2.50
2.50 ~ 3.525	3.525 ~ 3.575
3.575 ~ 3.725	3.725 ~ 4.10
4.10 ~ 6.90	6.90 ~ 7.03
7.03 ~ 7.10	7.10 ~ 7.50
7.50 ~ 10.50	10.50 ~ 14.10
14.10 ~ 14.50	14.50 ~ 18.50
18.50 ~ 21.15	21.15 ~ 21.50
21.50 ~ 25.50	25.50 ~ 29.00
29.00 ~ 30.00	30.00 ~ 51.00
51.00 ~ 52.00	52.00 ~ 53.00
53.00 ~ 60.00	

■ External Antenna Tuner type

If you want to use the external antenna tuner, AT-300 with the TS-480 transceiver, access Menu No. 27 and confirm that “At1” is selected (default). “At2” is reserved for future updates.

Note: When the AT-300 is used with the TS-480HX transceiver, TX power is automatically reduced to 100 W (AM mode: 25 W). Also, the AT-300 cannot be used for 50 MHz operation.

ATTENUATOR

The attenuator function is useful when extremely strong signals exist nearby your receiving frequency. When these type of signals exist nearby your receiving frequency, the AGC function may be erroneously controlled by the strong signals, rather than by the target receiving signal. If this happens, the target receiving signal can be masked and buried by the strong signals. In this case, turn the Attenuator function ON. When it is ON, the signal is attenuated approximately 12 dB.

- 1 Press [ATT/PRE/ ANT1/2] until the ATT icon appears on the display.
 - “ATT” appears when it is turned ON.

To return to normal operation, press [ATT/PRE/ ANT1/2] until both the ATT and the PRE icons disappear.

AUTO MODE

You can configure a maximum of 32 frequency borders (VFO A and B) to change the operating mode automatically as you change the VFO frequency.

As a default, the following modes are programmed on each operating band.

0.03 MHz ~ 9.5 MHz: LSB

9.5 MHz ~ 60 MHz: USB

To add the frequency borders to the Auto Mode selection:

- 1 Press and hold [MODE]+[ϕ] (POWER) to turn the transceiver ON.

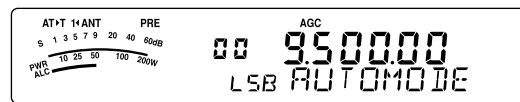

- “AUTOMODE” appears on the sub-display.
- 2 Select an Auto Mode frequency memory channel number by turning the MULTI control. Auto Memory channels 00 to 31 are available.
- 3 Turn the Tuning control to select a desired frequency border (or enter the frequency with the keypad {page 34}) to change the operating mode.
- 4 Press [MODE] or [MODE] (1 s) until the desired communication mode appears {page 19}.

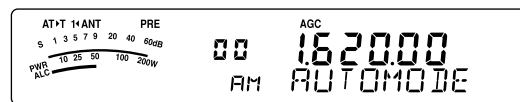

- 5 Repeat steps 2 ~ 4 until you have added all the data.
- 6 Press [MTR/ CLR] to exit the Auto Mode frequency configuration.

The table below shows the default Auto Mode frequency borders for the transceiver. When you access Menu No. 02 and select “on”, “AUTO” appears. The transceiver automatically selects the mode; LSB for frequencies below 9.5 MHz and USB for frequencies greater than or equal to 9.5 MHz (default).

Channel No.	Data	Operating mode
0	9.5 MHz LSB	0.03 MHz ≤ LSB < 9.5 MHz
1	9.5 MHz LSB	
2	9.5 MHz LSB	
3	9.5 MHz LSB	9.5 MHz ≤ USB ≤ 60.0 MHz
• •	• •	
31	9.5 MHz LSB	

13 OPERATOR CONVENIENCES

The table below is an example of how to add the frequency border of 1.62 MHz/ AM into memory. With this set up, the transceiver selects AM mode below 1.62 MHz, LSB mode from 1.62 MHz to 9.5 MHz and USB mode from 9.5 MHz to 60.0 MHz.

Channel No.	Data	Operating mode
0	1.62 MHz AM	0.03 MHz ≤ AM < 1.62 MHz
1	9.5 MHz LSB	
2	9.5 MHz LSB	1.62 MHz ≤ LSB < 9.5 MHz
3	9.5 MHz LSB	
•	•	9.5 MHz ≤ USB < 60.0 MHz
•	•	
31	9.5 MHz LSB	

The next table is an example of adding 4 frequency points into memory. With this setup, the transceiver selects AM mode below 1.62 MHz, CW mode from 1.62 MHz to 2.0 MHz, LSB mode from 2.0 MHz to 9.5 MHz, FM mode from 9.5 MHz to 53.0 MHz and USB mode from 53.0 MHz to 60.0 MHz. If multiple data contains the same frequency but a different mode is entered into memory, the lowest numbered memory channel is reflected as the Auto Mode.

Channel No.	Data	Operating mode
0	1.62 MHz AM	0.03 MHz ≤ AM < 1.62 MHz
1	2.0 MHz CW	
2	7.0 MHz LSB	1.62 MHz ≤ CW < 2.0 MHz
3	9.5 MHz LSB	
•	•	2.0 MHz ≤ LSB < 9.5MHz
•	•	
31	53.0 MHz FM	9.5 MHz ≤ FM < 53.0 MHz
		53.0 MHz ≤ USB < 60.0 MHz

To activate the Auto Mode function,

- 1 press **[MENU/ F.LOCK]**.
- 2 Turn the **MULTI** control to select Menu No. 02.
- 3 Press **[^]** to select "on".
- 4 Press **[MENU/ F.LOCK]** to store the setting and exit Menu mode.

BEEP FUNCTION

The Beep function provides you confirmation of entry, error status, and malfunctions of the transceiver. Although you can turn the beep function OFF by

accessing Menu No. 12, we recommend you leave it ON in order to detect unexpected errors and malfunctions.

You can also change the output level of the beeps by accessing Menu No. 12 and selecting "1" to "9" or "OFF".

The transceiver generates Morse code to tell you which mode is selected when you change operating modes.

When you change operating modes, the following Morse code sounds:

Mode	Morse Code Output
LSB	. - - (L)
USB	- - - (U)
CW	- . - . (C)
CWR	- . - . . - . (CR)
FSK	. - . (R)
FSR	. - . . - . (RR)
AM	. - (A)
FM	- - - (F)

The transceiver also generates the following warning, confirmation, and malfunction beeps.

Beeps	What it means
A high pitched short beep	A valid key is pressed.
A high pitched double beep	When a secondary function is selected.
A high pitched long beep	A key entry is accepted, Scan starts, or AT tune has completed.
A regular short beep	A function is turned OFF.
A low pitched short beep	An invalid key is pressed.
"UL" in Morse code	The internal PLL circuit unlock status is detected.
"S" in Morse code	CW Auto Tune cannot be completed, or an invalid frequency is entered.
"5" in Morse code	AT Tune cannot be completed within the specified time.
"SWR" in Morse code	The antenna's SWR is too high (over 10:1) to perform AT Tune.
"CHECK" in Morse code	1 minute before the APO (Auto Power Off) function switches the transceiver OFF. A protection circuit is ON. Invalid voltage is detected.
"BT" in Morse code	Waiting for a CW message to be recorded.
"AR" in Morse code	The current message memory is full.

DISPLAY

BRIGHTNESS

The brightness of the LCD display can be selected from OFF, and 1 to 4 by accessing Menu No. 00.

- 1 Press **[MENU/ F.LOCK]**, then turn the **MULTI** control to access Menu No. 00.
- 2 Press **[v]/ [^]** to select "oFF", "1", "2", "3", or "4".
- 3 Press **[MENU/ F.LOCK]** to store the setting and exit Menu mode.

KEY ILLUMINATION

The Remote Control panel key illumination can be switched ON or OFF.

- 1 Press **[MENU/ F.LOCK]**, then turn the **MULTI** control to access Menu No. 01.
- 2 Press **[v]/ [^]** to select "oFF" or "on".
- 3 Press **[MENU/ F.LOCK]** to store the setting and exit Menu mode.

LINEAR AMPLIFIER CONTROL

When you connect an external HF or 50 MHz linear amplifier to the transceiver using the **REMOTE** connector, select "1", "2", or "3" to activate the internal relay and/ or DC output (12 V) so you can interface with the HF/ 50 MHz linear amplifier {page 80}. The DC output (12 V) works without any annoying chattering sounds ("1") but the output current is limited to 10 mA. If your linear amplifier control circuit draws more than DC 12 V/ 10 mA, use the relay switching ("2" or "3") instead.

Also, some linear amplifiers require a long transmission delay time because of the slow antenna relay switching time. In this case, select "3" for the slow switching (25 ms delay).

- 1 Press **[MENU/ F.LOCK]**, then turn the **MULTI** control to select Menu No. 28 (HF) or 29 (50 MHz).
- 2 Press **[v]/ [^]** to select "oFF", "1", "2", or "3".

Parameter	Linear Amp. control	
	DC output (12 V)	Relay TX delay
oFF (default)	All controls	Disabled
1	Enabled	Disabled 10 ms
2	Enabled	Enabled 10 ms
3	Enabled	Enabled 25 ms

Note: If CW Full Break-in is enabled, 10 ms transmission delay is applied regardless of the settings in Menu Nos. 28 and 29.

LOCK FUNCTIONS

FREQUENCY LOCK FUNCTION

Frequency Lock disables some keys and controls to prevent you from accidentally activating a function or changing the current settings.

Press **[MENU/ F.LOCK]** (1 s) to turn the Frequency Lock function ON or OFF.

- "f" appears while this function is ON.

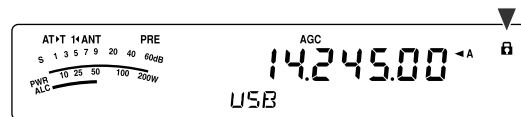

The following keys and controls are disabled by Frequency Lock:

Tuning control	MULTI control	ENT
QMI/ M.IN	SCAN/ SG.SEL	MODE
CW.T	QMR/ M▶VFO	A/B / M/V
A=B/ SPLIT	MHz	Mic [UP]
Mic [DWN]	v	^

Note:

- ◆ After activating Frequency Lock, the **MULTI** control and **[v]/ [^]** are still available in Menu mode.
- ◆ After activating Frequency Lock, you can still change the transmission frequency with the **Tuning** control while in TF-SET mode.
- ◆ After activating Frequency Lock, the **MULTI** control is still available for selections other than frequency and memory channel changes.
- ◆ After activating Frequency Lock, **[MTR/ CLR]** may be available in some situations.

TUNING CONTROL LOCK FUNCTION

The Tuning control lock function disables the **Tuning** control. The function can be used in the following situations:

- You do not want to change the operating frequency while you are driving the car.

To use the Tuning control lock function, first assign the function to the PF key on the Remote Control panel (or Mic PF keys).

- 1 Press **[MENU/ F.LOCK]** and turn the **MULTI** control to select Menu No. 48.
 - 2 Press **[v]/ [^]** to select "65".
 - 3 Press **[MENU/ F.LOCK]** to store the setting and exit the Menu mode.
 - 4 Press **[PF]**.
- "f" appears and the **Tuning** control is now locked.
- To return to normal operation, press **[PF]** again.

13 OPERATOR CONVENIENCES

MICROPHONE PF KEYS

When using the optional MC-47 microphone with the MJ-88 plug adaptor, you can customize the functions of the Microphone PF1 (CALL), PF2 (VFO), PF3 (MR), and PF4 (PF) keys. You can assign the following types of functions to these keys via Menu Nos. 49 ~ 52:

- Directly select a Menu No. without pressing **[MENU/ F.LOCK]** and turning the **MULTI** control.
- Activate the same function as one of the Remote Control panel keys.

One of the following functions can be assigned to each PF key. Selecting "99" assigns no function to the PF key.

PF KEY

You can program the Remote Control panel **[PF]** key to assign a function that you frequently use. The default is VOICE1 for the optional Voice Guide and Storage unit, VGS-1 {page 68}. You can assign one of the functions in "MICROPHONE PF KEYS" {above} to this PF key, accessing Menu No. 48.

Number	Function	Number	Function
0 ~ 60	Menu No. 00 ~ 60	80	M.IN
61	VOICE1	81	CW.T
62	VOICE2	82	CH1
63	RX Monitor	83	CH2
64	DSP RX Monitor	84	CH3
65	Freq. Lock	85	FINE
66	Send (TX)	86	CLR
67	TX tune	87	MTR
68	LSB↔USB	88	MHz
69	CW↔FSK	89	ANT1/2
70	FM↔AM	90	NB
71	TF-SET	91	NR
72	QMR	92	BC
73	QMI	93	DNL
74	SPLIT	94	—
75	A/B	95	—
76	M/V	96	—
77	A=B	97	—
78	SCAN	98	—
79	M▶VFO	99	No function

RX DSP EQUALIZER

EQUALIZING RECEIVING AUDIO

Use Menu No. 18 to change the receiver frequency responses of the target signal. You can select one from 8 different receiver profiles including the default flat response. Selecting any of the following items from the Menu causes "R \blacktriangleleft EQ" to appear on the display.

- **Off (oFF):**
The flat frequency response (default).
- **High boost 1 (hb1):**
Emphasizes higher audio frequencies.
- **High boost 2 (hb2):**
Emphasizes higher audio frequencies but lower audio frequency attenuation is less than High boost1 (hb1).
- **Formant pass (FP):**
Improves clarity by suppressing audio frequencies outside the normal voice frequency range.
- **Bass boost 1 (bb1):**
Emphasizes lower audio frequencies.
- **Bass boost 2 (bb2):**
Emphasizes lower audio frequencies but higher audio frequency attenuation is less than Bass boost1 (bb1).
- **Conventional (c):**
Attenuates 2 kHz or more audio frequency slightly.
- **User (U):**
Reserved for the ARCP software. Off (flat) is programmed at the factory as a default.

RX MONITOR

RX monitor disables the squelch function temporarily to monitor the current frequency activities.

To use the RX Monitor function, first assign the function to the PF key on the Remote Control panel (or Mic PF keys).

- 1 Press **[MENU/ F.LOCK]** and turn the **MULTI** control to select Menu No. 48.
- 2 Press [\blacktriangledown]/ [\blacktriangle] to select "63".
- 3 Press **[MENU/ F.LOCK]** to store the setting and exit the Menu mode.
- 4 Press **[PF]**.
 - While **[PF]** is pressed, the speaker unmutes.

TIME-OUT TIMER

The Time-out Timer limits the time of each transmission. It is also useful to prevent a long accidental transmission.

- 1 Press **[MENU/ F.LOCK]**, then turn the **MULTI** control to access Menu No. 22.
- 2 Press **[V]/ [^]** to select “oFF”, “3”, “5”, “10”, “20”, or “30” minutes.
- 3 Press **[MENU/ F.LOCK]** to store the settings and exit Menu mode.

TRANSVERTER

If you have a transverter that converts the TS-480 operating frequencies to other frequencies, you can use this TS-480 transceiver as a transverter exciter. Consult the instruction manual that came with the transverter for interfacing to the TS-480 transceiver.

■ Frequency Display

- 1 Connect the transverter to the ANT 1 or ANT 2 connector from the TX/ RX unit.
- 2 Select the exciter operating frequency on the transceiver.
 - The transverter will use this frequency as the reference for converting frequencies.
- 3 Access Menu No. 23, and select “on”.
 - The output power is automatically set to the lowest power for that frequency (default). Refer to “TX POWER” {below}.
- 4 Press **[MENU/ F.LOCK]** to store the setting and exit the Menu mode.
- 5 Press **[ENT]**, then set the target converting frequency using the numeric keys.
- 6 Press **[ENT]** to complete the entry.
- 7 The transceiver displays the target transverter frequency instead of the actual operating frequency.

Note: *When using a transverter, not all the functions of this transceiver are available.*

■ Transmission Output Power

If Menu No. 23 is selected “on” {above}, the transceiver automatically decreases the output power to 5 watts. However, if you do not wish to decrease the output power, you can turn this function OFF. Access Menu No. 24 and select “oFF”. The transceiver transmits at full power even if Menu No. 23 is ON {above}.

TX MONITOR

TX monitor allows you to monitor the on-going transmission sound. This is convenient when you want to check the modulation sound quality of the transmission. In FSK mode, you can monitor the FSK signal that the transceiver is transmitting.

- 1 Press **[PWR/ 4/ TX MON] (1 s)**.
- 2 The current TX monitor setting appears on the sub-display.
- 3 Turn the **MULTI** control to select the monitor sound level from “oFF”, and “1” to “9”.
- 4 Press **[MTR/ CLR]** to store the selected TX monitor level.

Note:

- ◆ *We recommend you use headphones when you monitor SSB, AM, or FM mode, in order to avoid howling.*
- ◆ *The CW transmission signal cannot be monitored using the TX monitor function. Use the TX sidetone function to monitor CW transmissions (Menu Nos. 13 and 34).*

TX POWER

You can adjust the transmission output power by pressing **[PWR/ 4/ TX MON]** and turning the **MULTI** control. If more precise power adjustment is required, access Menu No. 21 and select “on”. When this function is activated, the power adjustment steps change as shown in the table below.

TS-480SAT

Band	Mode	Menu No. 21 OFF	Menu No. 21 ON
HF band	SSB/ CW/ FM/ FSK	5 ~ 100 W in steps of 5	5 ~ 100 W in steps of 1
	AM	5 ~ 25 W in steps of 5	5 ~ 25 W in steps of 1
50 MHz	SSB/ CW/ FM/ FSK	5 ~ 100 W in steps of 5	5 ~ 100 W in steps of 1
	AM	5 ~ 25 W in steps of 5	5 ~ 25 W in steps of 1

TS-480HX

Band	Mode	Menu No. 21 OFF	Menu No. 21 ON
HF band	SSB/ CW/ FM/ FSK	5 ~ 200 W in steps of 5	5 ~ 200 W in steps of 1
	AM	5 ~ 50 W in steps of 5	5 ~ 50 W in steps of 1
50 MHz	SSB/ CW/ FM/ FSK	5 ~ 100 W in steps of 5	5 ~ 100 W in steps of 1
	AM	5 ~ 25 W in steps of 5	5 ~ 25 W in steps of 1

Note:

- ◆ *The output power settings are stored independently for HF and 50 MHz. As shown in the table above, you can also store different output power settings for AM and other modes for HF bands and the 50 MHz band.*
- ◆ *If the TS-480HX transceiver is connected to the AT-300 external antenna tuner, the TX power is automatically reduced to 100 W (AM mode: 25 W).*

13 OPERATOR CONVENIENCES

TX TUNE

The TX Tune function allows you to adjust the antenna length, or tune the linear amplifier while transmitting a continuous CW signal.

To use the TX Tune function, first assign the function to a PF key on the Remote Control panel (or Mic PF keys) {page 64}.

- 1 Press **[MENU/ F.LOCK]** and turn the **MULTI** control to select Menu No. 48.
- 2 Press **[v]/ [^]** to select "67".
- 3 Press **[MENU/ F.LOCK]** to store the setting and exit the Menu mode.
- 4 Press **[PF]**.
 - The transceiver automatically switches to CW mode, and transmits a continuous carrier. The transceiver selects the SWR meter function automatically.
 - While in TX Tune mode, most keys are disabled.
 - The default output power is configured as 10 watts. However, you can adjust the output power using **[PWR/ 4/ TX MONI]** and the **MULTI** control if necessary. The transceiver stores the new output power setting when you exit the TX Tune mode.
- 5 Press **[PF]** again to exit the TX Tune mode.

QUICK DATA TRANSFER

This transceiver has the capability to quickly and conveniently transfer the reception frequency and mode to another compatible transceiver. Compatible transceivers include:

- TS-480HX/ SAT
- TS-2000
- TS-570S/ 570D
- TS-870S

Data transfer could be useful while contesting. A spotting station that is searching for new contest multipliers can quickly transfer a frequency over to the running (main) station.

SETTING UP

■ Equipment Needed

In addition to a compatible transceiver, the following equipment is required:

Transfer to TS-480HX/ SAT, TS-2000, TS-570, or TS-870S:

- One cross-wired cable. This cable must have a DB-9 female connector at both ends.

■ Connections

For diagrams on how to connect the 2 transceivers, refer to "CONNECTING PERIPHERAL EQUIPMENT" {page 76}.

USING QUICK TRANSFER

When connecting with another TS-480HX/ SAT, TS-2000, TS-570, or TS-870S, use the same **COM** connector baud rate on each transceiver.

Note: While transferring data, other functions may work slower.

■ Transferring Data

The TS-480HX/ SAT transceiver works as the Master, sending data to the Slave transceiver.

- 1 Turn ON the Transfer function of each transceiver.
 - On the TS-480HX/ SAT, access Menu No. 53 and select "on". For the compatible transceiver, refer to the instruction manual that came with the transceiver.
- 2 On the Master, while in VFO mode, select an operating frequency and mode.
- 3 On the Master, press **[QMI/ M.IN]**.
 - When using another TS-480HX/ SAT as the Slave, "PC" appears on the Slave.
 - The displayed data is stored in Quick Memory channel 0 on the Master and transferred to the Slave.

Note: If the Master has RIT switched ON, the offset frequency is added to the reception frequency to be transferred.

■ Receiving Data

The TS-480HX/ SAT transceiver works as the Slave, receiving data from the Master transceiver. The Slave can receive data using either Quick Memory channel 0 or the VFO.

- 1 Switch ON the Transfer function of each transceiver.
 - On the TS-480HX/ SAT, access Menu No. 53 and select “on”. For the compatible transceiver, refer to the instruction manual that came with the transceiver.
- 2 On the Slave, access Menu No. 54 and select either “oFF” (QUICK MEMO channel 0) or “on” (the VFO).
 - The default is OFF (QUICK MEMO).
- 3 On the Master, perform the appropriate operation to send data.
 - For the correct method, refer to the instruction manual that came with the transceiver.

Note:

- ◆ *If you always use the TS-480HX/ SAT for receiving only, activate the TX Inhibit function, accessing Menu No. 55 to avoid unintentional transmission.*
- ◆ *When the Slave receives data using the VFO programmed with a simplex frequency, the received data replaces the data on both VFOs. On the Slave, both RIT and XIT are set to OFF.*
- ◆ *When the Slave receives data using the VFOs programmed with split frequencies, the received data replaces the data only on the TX side of the VFO. On the Slave, XIT is set to OFF but RIT is not changed.*

COMPUTER CONTROL

By connecting this transceiver to a computer, you can change the computer into an electronic console from which you can remotely control functions of the transceiver. This capability makes remote operation of your transceiver possible from across the room, from another room, or when coupled with other commercially available products and where lawful, from another city, state, or country via a telephone connection.

Note:

- ◆ *You can use the Remote Control panel controls while using computer control. Settings done from the Remote Control panel are effective immediately.*
- ◆ *After the computer is disconnected or turned off, all values and settings on the Remote Control panel are restored.*

SETTING UP

■ Equipment Needed

- A PC equipped with a COM (serial) port
- One straight cable. This cable must have a DB-9 female connector at one end, and a DB-9 or a DB-25 female connector that mates with the COM port of your computer at the other end.
- Transceiver control application

To create your programs, access the **KENWOOD** website (<http://www.kenwood.com/i/products/info/amateur.html>) and download the TS-480HX/ SAT command reference documents (PDF format) for details.

■ Connections

Connecting the transceiver to the computer is easy. Refer to the diagram in “CONNECTING PERIPHERAL EQUIPMENT” {page 76}.

Note: *Before connecting this transceiver to the computer, switch OFF the power to both the transceiver and the computer.*

COMMUNICATION PARAMETERS

In order to control the transceiver by computer, you must first choose the communication parameters.

- 1 On the computer, configure your transceiver control application for 8 data bits, 1 stop bit, and no parity.
- 2 On the transceiver, select the same transfer rate via Menu No. 56.
 - The defaults are 9600 bps and 1 stop bit.
 - 4800 bps is used for the Master/ Slave operation only (Parity ON and 2 stop bits).

13 OPERATOR CONVENIENCES

CONTROLLING THE TS-480 FROM PC

If a PC and the TS-480HX/ SAT are connected using a serial cable {page 76}, you can remotely control the functions of the TS-480 from a PC. Download the free ARCP-480 software from the following URL.

<http://www.kenwood.com/i/products/info/amateur.html>

The detailed remote controlling instructions are available in accompanied documents and help file.

REMOTE CONTROLLING THE TS-480 ON THE NETWORK

In addition to the ARCP-480 program, the ARHP-10 program can also be downloaded from the above site. This ARHP-10 program is a ARCP-480 host program that allows a user who is connected in the network to remote control the TS-480 transceiver from a distant location. If you make interface cables that transfer the audio between the TS-480 transceiver and PC on the host transceiver, you can receive signals and transmit your voice over the network. For detailed information, download the ARHP-10 program and consult accompanied documents.

VGS-1 VOICE GUIDE & STORAGE UNIT (OPTIONAL)

The optional VGS-1 unit allows you to record a maximum of 30-second voice message to 3 different memory channels. After recording a message via your transceiver microphone, you can then transmit those recorded messages. It also announces the key function and frequencies each time you press a key (Voice announcement). Since the incoming reception signal is processed in digital data in the transceiver, the VGS-1 can be configured to store the incoming audio signals constantly in the background. If you wish, you can store the last 30-second of the incoming signal to the VGS-1 for the later playback (Constant recording).

For information on how to install the VGS-1 unit, refer to "INSTALLING OPTIONS" {page 81}.

RECORDING MESSAGES

This section explains how to record a single message.

- 1 Select SSB, FM, or AM mode {page 19}.
 - Select a mode that you wish to transmit.
- 2 If VOX is ON, press **[VOX/ 8]** to switch the function OFF.
- 3 Press **[CH1/ 1/ REC] (1 s)** to record the message for channel 1.
 - BT in Morse code sounds and "AP1 –" appears.

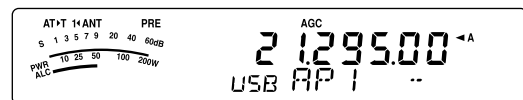

- To quit recording your message, press **[MTR/ CLR]**.
- 4 Press and hold **[CH1/ 1/ REC]**, then begin speaking into your microphone.
 - Three channels are available for recording messages. Press channel key **[CH2/ 2/ REC]** or **[CH3/ 3/ REC]** in place of **[CH1/ 1/ REC]**, in step 3, to record the message on a different channel.
 - While the Constant Recording is working, CH3 is unavailable for the message recording.
 - 5 Release the key pressed in step 4 when you have finished recording your message.
 - Also when the maximum recording time passes, recording automatically stops.
 - The contents of the channel is overwritten with the new message.
 - "FLASH WR" appears while the transceiver is storing the message data to the VGS-1 flash memory.
 - 6 Repeat steps 3 to 5 to record a message on another channel.

Note: Pressing **[φ]** (POWER) cancels recording in progress and clears the memory channel.

MESSAGE PLAYBACK

You can play back the message in channel 1, 2, or 3 to check or to send. It is also possible to make a longer message by consecutively playing back the messages of more than one channel, linking them together.

You can even repeatedly send a longer, linked message by using the Repeat function. To switch this function ON, access Menu No. 31 and select "on" (default is OFF). Then, select the repeat interval time in Menu No. 32 (default is 10 seconds).

Note:

- ◆ Pressing [ϕ] (POWER) cancels playback in progress.
- ◆ The settings in Menu Nos. 31 and 32 are shared with CW Message Playback described in "CW MESSAGE MEMORY" (page 40).

■ Checking Messages

- 1 Select SSB, FM, or AM mode.
 - Select the same mode when you recorded the message.
 - Confirm the VOX function is OFF.
- 2 Press [CH1/ 1/ REC], [CH2/ 2/ REC], or [CH3/ 3/ REC], depending on which channel you want to check.
 - For example, "AP 1--" appear while playing back the message in channel 1.

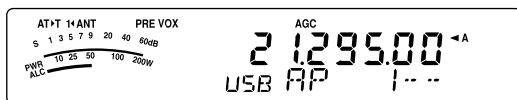

- To interrupt playback, press [MTR/ CLR].
- 3 To play back another message in sequence, press the corresponding key ([CH1/ 1/ REC], [CH2/ 2/ REC], or [CH3/ 3/ REC]) while the first message is being played.
 - Up to 3 channels can be queued.



■ Sending Messages

- 1 Select SSB, FM, or AM.
 - Select the same mode when you recorded the message.
- 2 Press [VOX/ 8] to switch VOX ON or OFF.
 - If you switched VOX ON, skip step 3.
- 3 Press and hold Mic [PTT].
- 4 Press [CH1/ 1/ REC], [CH2/ 2/ REC], or [CH3/ 3/ REC], depending on which channel you want to use.
 - For example, "AP 1--" appear while playing back the message in channel 1.



- To interrupt playback, press [MTR/ CLR].

- 5 To play back another message in sequence, press the corresponding key ([CH1/ 1/ REC], [CH2/ 2/ REC], or [CH3/ 3/ REC]) while the first message is being played.
 - Up to 3 channels can be queued.

- 6 Release Mic [PTT].

■ Erasing a Recorded Message

- 1 Press [CH1/ 1/ REC] (1 s) or [CH2/ 2/ REC] (1 s) or [CH3/ 3/ REC] (1 s) to select the message which you want to erase.
 - "APn --" appear, where "n" represents the channel number.
- 2 To erase the recorded message, press and hold the same key as in step 1 ([CH1/ 1/ REC], [CH2/ 2/ REC], or [CH3/ 3/ REC]), while simultaneously pressing [MTR/ CLR].
 - A beep sounds and the message is erased.

■ Changing Inter-message Interval Time

For repetitive message playback, you can change the interval between each series of messages. Use Menu No. 32, and select the time in the range of 0 to 60 seconds.

■ Changing Message Playback Volume

Turning the **AF** control does not change the volume for the message playback. To change the message playback volume, access Menu No. 14 to select the playback volume level from "1" to "9" or "oFF".

CONSTANT RECORDING

By utilizing the digital recording capability of the VGS-1, you can configure the VGS-1 to store the last 30-second of the incoming reception signal to the VGS-1. It is similar to a flight recorder that is used in an aircraft. You can play back the last 30 seconds of the reception signal to confirm what has been heard.

To activate the Constant Recording function, access Menu No. 30 and select "on". "☑" appears and the transceiver starts recording the signal in background. When you press [CH3/ 3/ REC] (1 s), the VGS-1 stores a maximum of last 30-second of the reception audio signal to the flash memory. While writing the audio signal data to flash memory, "FLASH WR" appears for a while. To playback the stored reception signal, press [CH3/ 3/ REC].

To play back the stored reception sound, press [CH3/ 3/ REC]. To quit, press [MTR/ CLR].

Note:

- ◆ While the Menu No. 30 is ON, you cannot use the Channel 3 (CH3) message memory to record and playback your voice message. However, the message in CH3 is not erased. When the Constant Recording function is turned OFF (Menu No.30 is OFF), you can playback the message on Channel 3 (CH3).
- ◆ While the "☑" icon disappears, such as the VGS-1 is playing back a message or the Voice Guide function is working, the Constant Recording function temporarily pauses.
- ◆ When you record a new message to the VGS-1, 30-second Constant Recording buffer is cleared.
- ◆ You cannot transmit a stored audio signal that is recorded with the Constant Recording function.

13 OPERATOR CONVENIENCES

VOICE GUIDE

When the optional VGS-1 is installed, each time you change the transceiver mode such as VFO A/B or Memory Recall, the transceiver automatically announces the new mode. In addition, you can program the Remote Control panel **[PF]** key so that pressing it makes the transceiver announce the displayed information. If you have the optional MC-47 microphone with MJ-88 plug adaptor, you can program one of the Mic **[PF]** keys for this function as well.

The table below indicates what the transceiver automatically announces when it changes the settings.

Key Pressed	Operation	Announcement
[A/B]	VFO A	"S" ¹ + A/B + Frequency
	VFO B	
[V], [^]	Band change	Frequency
[A/B / M/V] (1 s)	VFO or Memory Recall	VFO + "S" ¹ + A/B + Frequency or Channel + Memory No. + Frequency or "blank"
[MENU/ F.LOCK]	Menu No. selection	Menu + No. + Selected number + Parameter
[V], [^]	Menu Parameter change	Selected parameter
[QMI/ M.IN] (1 s)	Memory Scroll mode	Memory in + Memory No. + Frequency
[ENT]	Frequency entry	Enter
MULTI control	Menu No. changes	No. + Selected number + Parameter
	Memory channel No. changes	Memory channel No. + Frequency
	Settings for various functions	Parameter value
Numeric key entry	Entering numbers	Every number entered
Function key	Selecting a function	Function name + Parameter
Freq. Lock function	Frequency lock status	Frequency lock ON/OFF
Quick Memory recall	Recall Quick Memory	Quick memory + Memory number + "S" ¹ + A/B + Frequency

¹ "S" is announced when the transceiver is operating in Split-frequency mode.

² The PF key assignment parameter is announced as the number shown below.

Menu number	61	VOICE1	62	VOICE2	63	RX MONI	
64	DSP RX MONI	65	FREQ. LOCK	66	SEND (PTT)	67	TX TUNE
68	USB LSB	69	CW FSK	70	FM AM	71	TF-SET
72	QMR	73	QMI	74	SPLIT	75	A/B
76	M/V	77	A=B	78	SCAN	79	M>V
80	M.IN	81	CW.T	82	CH1	83	CH2
84	CH3	85	FINE	86	CLR.	87	MTR
88	MHz	89	ANT1/2	90	NB	91	NR
92	BC	93	DNL	99	OFF		

For the **[PF]** key, the transceiver will announce different information, depending on whether VOICE1 or VOICE2 is selected.

VOICE1:

- The frequency on display, channel number, various mode settings, and Menu settings are announced.
- The frequency for the VFO or memory channel will be announced to 10 Hz digit. For the MHz decimal point, "point" is announced. If the memory channel has no data stored, "blank" is announced.
- If a memory channel that has no data is selected in Memory Scroll mode, "blank" is announced.

Note: If operating a key or a control changes the contents of the display while an announcement is in progress, the announcement is interrupted.

VOICE2:

- The S-meter readings at the time you pressed the key, are announced, for example, "S5" or "20 dB".

The table below shows the available announcements when the **[PF]** (VOICE2) is pressed.

S-Meter Level	Announcement	S-Meter Level	Announcement
0	S0	10	S8
1 ~ 3	S1	11	S9
4	S2	12	10 dB
5	S3	13 ~ 14	20 dB
6	S4	15	30 dB
7	S5	16 ~ 17	40 dB
8	S6	18	50 dB
9	S7	19 ~ 20	60 dB

1 Assign VOICE1 (61) or VOICE2 (62) to the Remote Control panel **[PF]** key by accessing Menu No. 48. Or, if you are using the optional MC-47 microphone, assign one of the Mic **[PF]** keys to either VOICE1 or VOICE2. For programming Mic **[PF]** keys, refer to "MICROPHONE PF KEYS" {page 64}.

2 Press the **[PF]** key that you programmed.

- An announcement is made based on the VOICE1 or VOICE2 selection.
- To interrupt the announcement, press the **[PF]** key again.

■ Voice Guide Announcement Volume

Turning the **AF** control does not change the volume for the Voice Guide announcement volume. To change the announcement volume, access Menu No. 15 to select the volume level from “1” to “7” or “oFF”.

■ Voice Guide Announcement Speed

If you feel the Voice Announcement speed is too slow or fast, you can adjust the Voice Announcement speed. Five different speed can be configured. Access Menu No. 16 and select “0” to “4”. 0 is the slowest speed and 4 is the fastest speed. The default speed is 1.

CROSSBAND REPEATER

If you have a TM-D700 transceiver and another VHF or UHF transceiver, you can set up the TS-480 transceiver and TM-D700 transceiver as a crossband repeater. The TM-D700 will receive signals you transmit from the additional VHF or UHF transceiver when both transceivers are set with the same frequency. The signal is then routed to the TS-480 transceiver and retransmitted on the frequency you have set upon the TS-480 transceiver. Likewise, signals received on the TS-480 transceiver are routed to the TM-D700 and retransmitted to the transceiver you have with you, allowing you to hear the received call in a distant location.

To interface between the TS-480 transceiver and TM-D700 transceiver, refer to “CROSSBAND REPEATER” for details (page 79).

You need a cable that has mini-DIN (6-pin) male connector at both ends.

***Note:** For the repeater function to operate, the squelch levels of both transceivers (TS-480 and TM-D700) must be adjusted properly so that no background noise can be heard. Because the transmission is controlled by monitoring the squelch status only.*

Operation

The crossband repeater function uses 2 frequency bands to receive and transmit signals. When a signal is received on one band, it is retransmitted on the other band.

- 1 Select a desired transmission/ reception VHF or UHF frequency on the TM-D700 transceiver.
- 2 Confirm PTT icon is visible on the crossband repeater frequency on the TM-D700 transceiver.
- 3 Select the same frequency for the terminal transceiver.
- 4 Select a desired HF/ 50 MHz frequency on the TS-480 transceiver.
- 5 Adjust the squelch threshold level so that both TS-480 transceiver and TM-D700 transceiver mute.
- 6 Press [**MENU/ F. LOCK**] on the TS-480, then turn **MULTI** control to access Menu No. 57.
- 7 Press [**^**] to select “on”.
 - When the TS-480 transceiver’s squelch opens, the TM-D700 transceiver retransmits the incoming audio signal on the VHF or UHF frequency at the same time.
 - When the TM-D700 transceiver’s squelch opens, the TS-480 transceiver retransmits the incoming audio signal on the HF/ 50 MHz frequency.
- 8 Access Menu Nos. 46 and 47 and press [**∨**]/ [**^**] to adjust the input/ output audio level.
- 9 To quit the TM-D700 repeater operation, disconnect the interface cable between transceivers and access Menu No. 57 on the TS-480 transceiver and select “oFF”.

13 OPERATOR CONVENIENCES

DX PACKETCLUSTER TUNE

If you have the TM-D700 transceiver, you can connect the TM-D700 to the TS-480HX/ SAT transceiver to use the DX PacketCluster Tune function. Connect the 2 transceivers with a cross-wired DB-9 cable as shown on page 79.

- 1 Press **[MENU/ F.LOCK]** and turn **MULTI** control to select Menu No. 56 on the TS-480 transceiver.
- 2 Press **[↘]/ [↗]** to select the same communication baud rate that the TM-D700 transceiver is configured.
- 3 Tune to the DX PacketCluster node frequency on the TM-D700 transceiver.
- 4 Press **[F] (1 s)**, **[TNC]** on the TM-D700 transceiver.
 - “TNC APRS” appears on the TM-D700 display.
- 5 Press **[F] (1 s)**, **[DX]** on the TM-D700 transceiver.
 - Every time the DX station’s information is reported to the DX PacketCluster node, the TM-D700 stores and list the report to the memory.
- 6 Select a desired DX station data with **[↑]/ [↓]** on the TM-D700 transceiver.
- 7 Press **[MHz]** on the TM-D700 to transfer the frequency data to the TS-480 transceiver.
 - If the transferred frequency data is available on the TS-480 transceiver, the frequency data will be overwritten to the current operating frequency. Otherwise, the operating frequency of the TS-480 transceiver remains unchanged.

For more detailed operation on the DX PacketCluster operation of the TM-D700 transceiver, refer to page 6 of the TM-D700 instruction manual (Specialized Communications).

Note: *The firmware of the TM-D700 transceiver must be version G2.0 or later to use the DX PacketCluster Tune function.*

SKY COMMAND II (K-TYPE ONLY)

The Sky Command II allows you to remotely control the TS-480HX/ SAT transceiver from a separate location.

If you have more than 2 TH-D7A and/ or TM-D700A transceivers, you can perform Sky Command II operation to remotely control the HF/ 50 MHz band of your TS-480 transceiver.

You will use one transceiver (TH-D7A or TM-D700A) as a remote control unit, called a "Commander". The other VHF/ UHF transceiver (TH-D7A or TM-D700A) with the TS-480 transceiver is called the "Transporter". This TH-D7A or TM-D700A transceiver will function as an interface between the Commander (a remote control unit) and the HF/ 50 MHz band of the TS-480 transceiver.

This system allows you, for example, to watch for and hunt DX while washing your car, or to operate the HF transceiver while relaxing in your car, living room, or patio, instead of actually operating inside your shack.

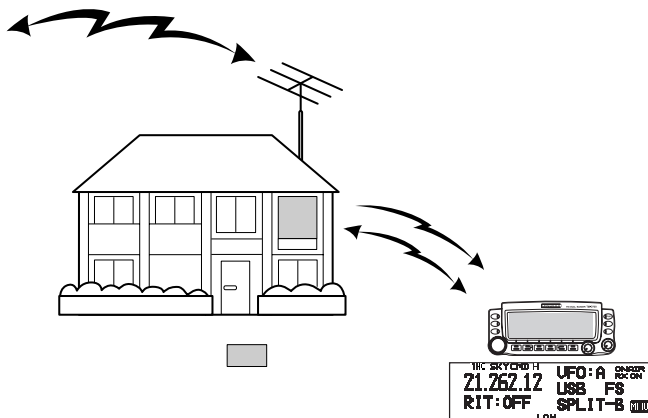

SKY COMMAND II DIAGRAM

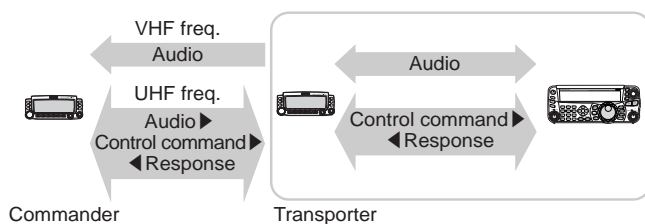

PREPARATION

Although you can use either a TM-D700A, a TH-D7A transceiver as a "Commander" (an external remote control unit), the following procedure shows how to set up your TS-480 and TH-D7A or TM-D700A transceivers as a "Transporter" at a base station and the TM-D700A transceiver as a "Commander".

Starting Sky Command II operation:

After you have completed the following setups, you can start Sky Command II operation. Without programming these parameters, you cannot perform Sky Command II operation.

TS-480 + TH-D7A/ TM-D700A (Transporter) Setup:

- 1 Configure the TH-D7A or TM-D700A as a "Transporter" and connect all the necessary cables to the TS-480 transceiver.
- 2 Select a frequency (HF/ 50 MHz band) on the TS-480 transceiver.
- 3 On the TS-480, press **[MENU/ F.LOCK]**, then turn the **MULTI** control to access Menu No. 56, then select the desired communication speed.
- 4 Select the same communication parameters to match the TH-D7A or TM-D700A transceiver.
- 5 Press **[MENU/ F.LOCK]** to complete.
- 6 Configure and start the Transporter mode on the TH-D7A or TM-D700A transceiver.

On the TM-D700A (Commander):

- 1 Select the same VHF and UHF frequencies that you selected for the Transporter.
- 2 Access Menu 4-4 to select COMMANDER.
 - "PRESS [0] KEY TO START COMMANDER!!" appears.
- 3 Press **[0]** on the DTMF Mic of the TM-D700A to start the Sky Command II operation.

CONTROL OPERATION

After setting up both the Transporter and the TM-D700A (Commander) for Sky Command II operation, press Mic **[0]** on the Commander. While in Sky Command II mode, the Mic keys of the Commander will function as described below.

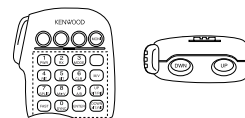

Each time you press a key, the Commander will automatically enter Transmission mode and send the corresponding control command to the Transporter.

To switch the HF transceiver OFF	Press Mic [1] .
To change the frequency or memory channel on the HF transceiver	Press Mic [UP]/ [DWN] .
To transmit audio on an HF frequency	Press and hold Mic [PTT] , then speak into the microphone.
To receive audio on an HF frequency	Press Mic [2] .
To monitor the UHF band on the Commander	Press the Mic PF key assigned to the Monitor function.

13 OPERATOR CONVENIENCES

Mic Key	Function
1	Power OFF
2	HF frequency receive ON/ OFF
3	Modulation mode switch
4	RIT ON/ OFF
5	XIT ON/ OFF
6	RIT offset or XIT offset clear
7	Split-frequency ON/ OFF
8	Transfer from Memory to VFO
9	In VFO mode: VFO A/ VFO B switch In Memory Recall mode: No change
0	Current settings retrieve (from HF transceiver)
B	VFO/ Memory Recall mode switch
C	XIT/ RIT offset frequency increase
D	XIT/ RIT offset frequency decrease
* ¹	In LSB, USB, or CW mode: 10 Hz/ 1 kHz switch In FM or AM mode: 1 kHz/ 10 kHz switch
# ²	In VFO mode: Frequency entry ON In Memory Recall mode: Channel number entry ON

¹ "FS" appears when you select 1 kHz step (LSB/ USB/ CW) or 10 kHz step (FM/ AM).

² After pressing Mic [#], press Mic [0] to [9] to enter a frequency or memory channel number.

When Mic [0] is pressed, the Commander shows the current settings of the HF transceiver:

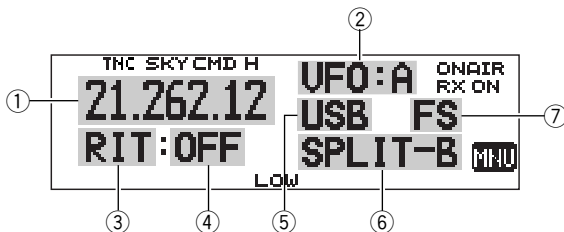

- ① HF frequency
- ② VFO: A, VFO: B,
MR: 00 ~ 99 (memory channel)
- ③ RIT, XIT
- ④ OFF, -9.99 ~ +9.99
- ⑤ LSB, USB, CW, FM, or AM
- ⑥ SPLIT-A: VFO A is used for transmitting.
SPLIT-B: VFO B is used for transmitting.
SPLIT-M: A memory channel is used for transmitting.
- ⑦ "FS" appears when Mic [*] is pressed.

Note:

- ◆ After pressing [MENU], you can access only Menu 4-4.
- ◆ The Transporter will transmit its call sign in Morse code every 10 minutes, using the 144 MHz band.
- ◆ The APO timer will not operate on the transceiver while the Transporter is ON.

USING TH-D7A AS A COMMANDER

To use a TH-D7A transceiver as a "Commander" (an external remote control unit), follow the steps below. Basically, it is the same as using a TM-D700A as a "Commander" (described on the previous page).

TS-480 + TH-D7A/ TM-D700A (Transporter) Setup:

- 1 Configure the TH-D7A or TM-D700A as a "Transporter" and connect all the necessary cables to the TS-480 transceiver.
- 2 Select a frequency (HF/ 50 MHz band) on the TS-480 transceiver.
- 3 On the TS-480, press [MENU/ F.LOCK], then turn the **MULTI** control to access Menu No. 56.
- 4 Select the same communication parameters that you selected for the TH-D7A or TM-D700A transceiver.
- 5 Press [MENU/ F.LOCK] to complete.
- 6 Start the Transporter mode on the TH-D7A or TM-D700A transceiver.

TH-D7A (Commander) Setup:

- 1 Access Menu 4-1 to enter the same callsign that you entered for the Commander (ex: WD6DJY).
- 2 Access Menu 4-2 to enter the same callsign that you entered for the Transporter (ex: WD6DJY-1).
- 3 Access Menu 4-3 to select the same CTCSS tone frequency that you selected for the Transporter.
- 4 Set the same frequencies that you selected for the "Transporter" for the VHF and UHF bands.

Note: Refer to Chapter 19, Sky Command II, of the TH-D7A instruction manual for details on how to enter the callsign and CTCSS tone frequency.

CONTROL OPERATION

First, switch the TS-480 and TH-D7A or TM-D700A transceivers (Transporter) ON. Configure the TH-D7A or TM-D700A to enter the "Transporter" mode.

Then, access Menu 4-4 on the TH-D7A and select "COMMANDER". "PUSH [0] KEY TO START COMMANDER!!" appears.

Press [0] on the TH-D7A to start Sky Command II mode.

When in Sky Command II mode, the keys of the TH-D7A (Commander) will function as described below. Only [LAMP], [MONI], and the VOL control functions will not change.

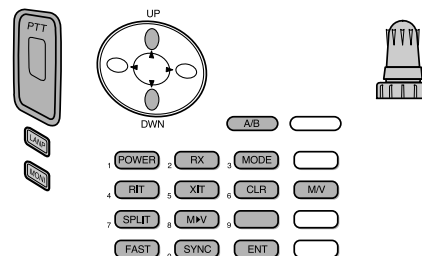

Each time you press the desired key, the Commander will automatically enter Transmission mode and send the corresponding control command to the Transporter.

To switch the HF transceiver OFF	Press [POWER] .
To transmit audio on an HF frequency	Press and hold the PTT switch, then speak into the microphone.
To receive audio on an HF frequency	Press [RX] .
To monitor the UHF band on the Commander	Press and hold [MONI] .

Note:

- ◆ On the Transporter, only **[LAMP]**, **[MONI]**, and **[MENU]** will function. Pressing any other key will simply cause the Transporter to generate an error beep.
- ◆ After pressing **[MENU]**, you can access only Menu 4–4.
- ◆ The Transporter will transmit its call sign in Morse code every 10 minutes, using the 144 MHz band.
- ◆ The APO timer will not operate on the transceiver while the Transporter is ON.

Key	Function
Tuning control	Frequency or memory channel number change
UP/DWN	RIT offset or XIT offset change
A/B	In VFO mode: VFO A/ VFO B switch In Memory Recall mode: No change
POWER ¹	Power ON/ OFF
RX ¹	HF frequency receive ON/ OFF
MODE ¹	Modulation mode switch
RIT ¹	RIT ON/ OFF
XIT ¹	XIT ON/ OFF
CLR ¹	RIT offset or XIT offset clear
SPLIT ¹	Split-frequency ON/ OFF
M▶V ¹	Transfer from Memory to VFO
FAST	In LSB, USB, or CW mode: 10 Hz/ 1 kHz switch In FM or AM mode: 1 kHz/ 10 kHz switch
SYNC ¹	Current settings retrieve (from HF transceiver)
ENT	In VFO mode: Frequency entry ON In Memory Recall mode: Channel number entry ON
M/V	VFO/ Memory Recall mode switch

¹ After pressing **[ENT]**, you can use these keys as numeric keys to enter a frequency or memory channel number.

When **[0/ SYNC]** is pressed, the Commander shows the current settings of the TS-480 transceiver:

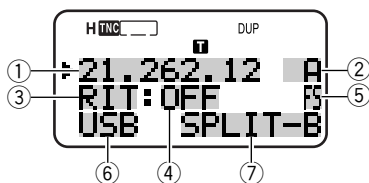

- ① HF frequency
- ② A (VFO A), B (VFO B), 00 ~ 99 (memory channel number)
- ③ RIT, XIT
- ④ OFF, -9.99 ~ +9.99
- ⑤ “FS” appears when **[FAST]** is ON.
- ⑥ LSB, USB, CW, FM, or AM
- ⑦ SPLIT-A: VFO A is used for transmitting.
SPLIT-B: VFO B is used for transmitting.
SPLIT-M: A memory channel is used for transmitting.

CONNECTING PERIPHERAL EQUIPMENT

COMPUTER

The **COM** connector allows you to directly connect a computer or dumb terminal by using a straight-wired cable, having a DB-9 female connector at each end.

No external hardware interface is required between your computer and the transceiver.

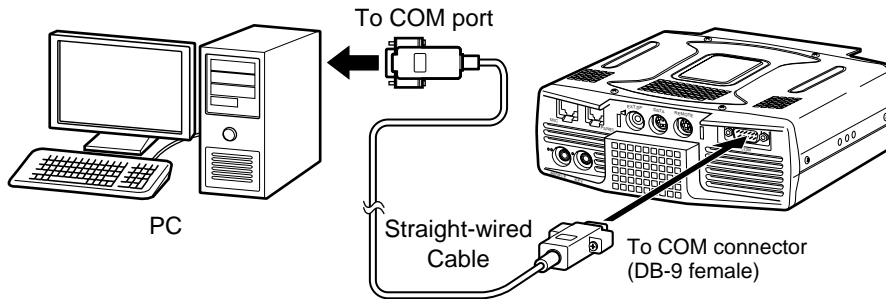

COMPATIBLE TRANSCEIVER

When transferring data to or from another TS-480, TS-2000, TS-570, or TS-870S, directly connect the 2 transceivers using the **COM** connectors.

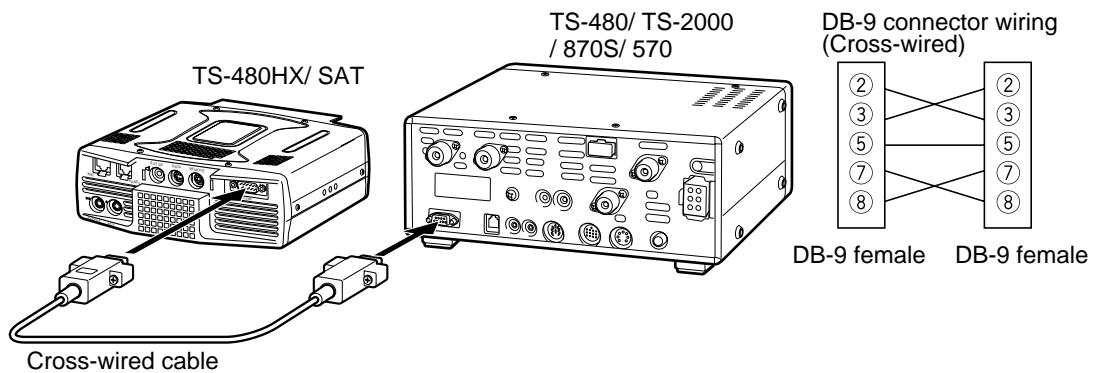

RTTY OPERATION

Use the **REMOTE** and **DATA** connectors to interface with your MCP. If your MCP supports RTTY keying output, connect the output to pin 8 of the **REMOTE** connector. Connect the demodulation input line of the MCP to pin 5 of the **DATA** connector {page 78}. Also, connect the transmission control line of the MCP to pin 3 of the **REMOTE** terminal. Select "FSK" or "FSR" when you operate the RTTY mode.

Note: Do not share a single power supply between the transceiver and the RTTY equipment. Keep as wide a separation as possible between the transceiver and the RTTY equipment to reduce noise-pickup by the transceiver.

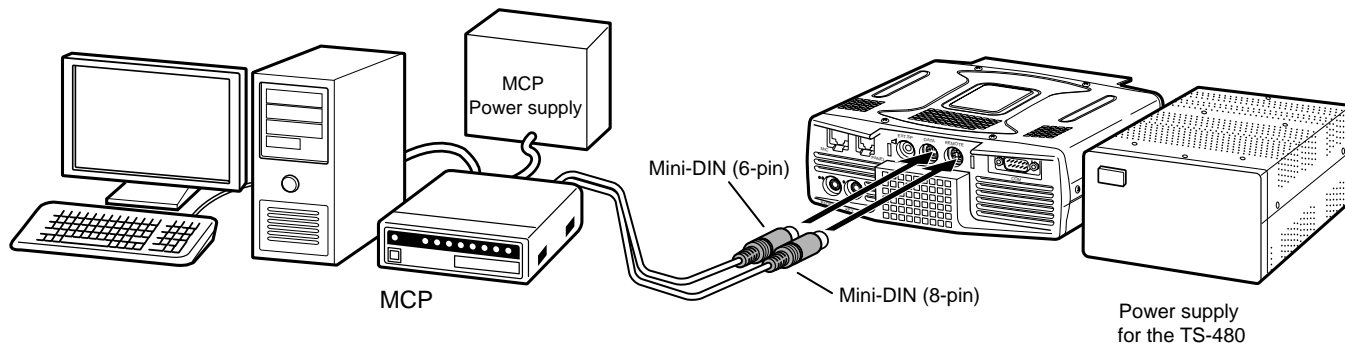

HF/ 50 MHz LINEAR AMPLIFIER

Connect an external transmission power amplifier to the **REMOTE** connector (1 male, 8-pin mini DIN connector (E57-0405-XX) is supplied). Switch ON the linear amplifier control relay via Menu Nos. 28 (HF) and 29 (50 MHz). Select "2" or "3" if you use the internal relay to control the linear amplifier status.

The TX/ RX relay response time is 10 ms when you have selected CW Full Break-in and 25 ms when you have selected CW Semi Break-in.

Note:

- ◆ The TX/ RX control method differs, depending on external amplifier models. Some amplifiers enter the TX mode when the control terminal is grounded. For those amplifiers, connect pin 2 of the **REMOTE** connector to the GND terminal of the amplifier and connect pin 4 of the connector to the control terminal of the amplifier.
- ◆ The mini DIN connectors (**DATA** and **REMOTE** connectors) look alike. Confirm the number of pins before plugging into the transceiver connectors. The **REMOTE** connector is an 8-pin mini DIN connector and the **DATA** connector is a 6-pin mini DIN connector.

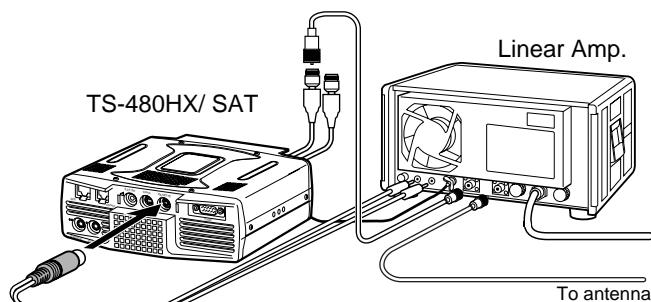

Use the supplied mini DIN (8-pin) connector to interface with the Linear Amp.

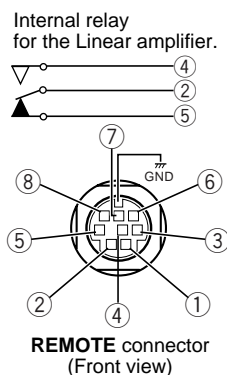

REMOTE terminal pin assignment (8-pin mini DIN)

Pin No.	Pin Name	Function
1	SPO	Speaker output
2	COM	Common terminal of the relay
3	SS	Ground this terminal to transmit. ANI (DATA connector) terminal turns OFF.
4	MKE	Connects to COM (pin 2) when the transceiver transmits.
5	BRK	Connects to COM (pin 2) when the transceiver receives.
6	ALC	ALC input from amplifier (-7 V)
7	RL	Approx. +12 V DC is output when the transceiver transmits (10 mA max.).
8	RTK	RTTY (FSK) keying input. Ground this terminal to alternate Mark and Space.
Metal cover	-	Ground

14 CONNECTING PERIPHERAL EQUIPMENT

ANTENNA TUNER

Use the ANT 1 and AT connectors to connect an AT-300 external antenna tuner. If you connect the external antenna tuner to the ANT 2 connector, it will not function.

Note: When the AT-300 is used with the TS-480HX transceiver, the TX output power is automatically reduced to 100 W (AM mode: 25 W). Also, the AT-300 cannot be used for 50 MHz operation.

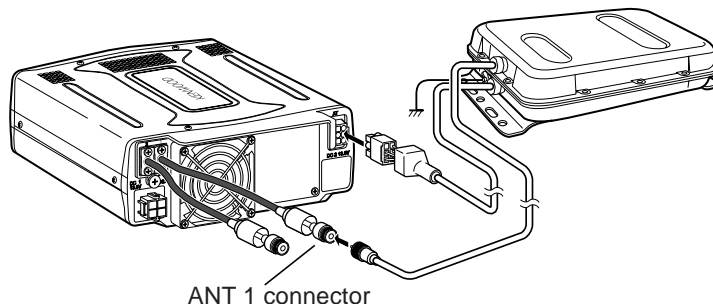

MCP AND TNC

Use the **DATA** connector to connect the AF input/ output lines from a Terminal Node Controller (TNC) for Packet operation, a Multimode Communications Processor (MCP) for operation on AFSK, Packet, PacTOR, AMTOR, G-TOR™, PSK31, or FAX, or a Clover interface. Also use the **DATA** connector to connect SSTV and phone patch equipment (1 male, 6-pin mini DIN connector (E57-0404-XX) is supplied).

- Connect the TNC or MCP to the **DATA** connector using a cable equipped with a 6-pin mini DIN plug.
- Connecting the TNC or MCP to a personal computer or dumb terminal requires an RS-232C cable.
- Select LSB or USB mode (it depends on the communication mode) when you operate the MCP/ TNC.

Note:

- ◆ Do not share a single power supply between the transceiver and the TNC or MCP. Keep as wide a separation as possible between the transceiver and the computer to reduce noise-pickup by the transceiver.
- ◆ The mini DIN connectors (**REMOTE** and **DATA** connectors) look alike. Confirm the number of pins before plugging into the transceiver connectors. The **DATA** connector is a 6-pin mini DIN connector and the **REMOTE** connector is an 8-pin mini DIN connector.

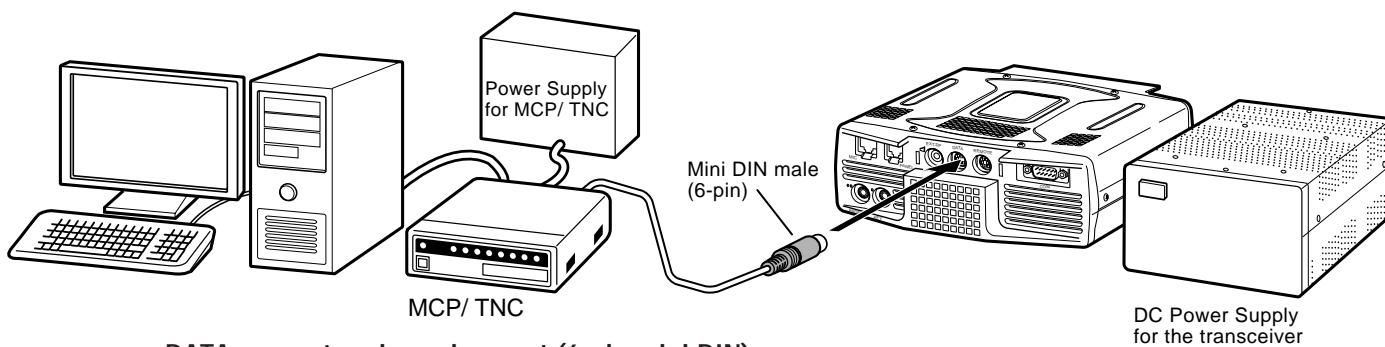

DATA connector pin assignment (6-pin mini DIN)

Pin No.	Pin Name	Function
1	ANI	Audio input from MCP/ TNC
2	ANG	Audio signal ground
3	DTS	Ground this terminal to transmit. When it is grounded, the microphone input turns OFF.
4	NC	No connection
5	ANO	Audio output for MCP/ TNC
6	SQC	Squelch status • Squelch open: Low impedance • Squelch close: High impedance
Metal cover	GND	Ground

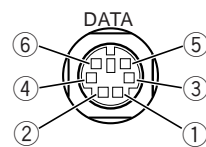

DATA connector (Front view)

DX PACKETCLUSTER TUNE

If you have a TM-D700 transceiver, you can connect the TM-D700 to the TS-480 transceiver to use the DX PacketCluster Tune function. Connect the 2 transceivers with a cross-wired RS-232C cable as shown below. Configure the TM-D700 transceiver to the DX PacketCluster node frequency.

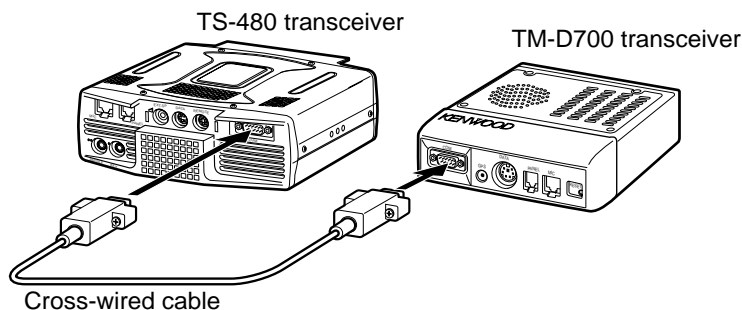

- 1 Press **[MENU/ F.LOCK]** and turn the **MULTI** control to select Menu No. 56 on the TS-480 transceiver.
- 2 Press **[<v>]**/ **[<^>]** to select the same communication baud rate configured on the TM-D700 transceiver.
- 3 Tune to the DX PacketCluster node frequency on the TM-D700 transceiver.
- 4 Press **[F] (1 s)**, **[TNC]** on the TM-D700 transceiver.
 - “TNC APRS” appears on the TM-D700 transceiver.
- 5 Press **[F] (1 s)**, **[DX]** on the TM-D700 transceiver.
- 6 Select a desired DX station data with **[<u>]**/ **[<d>]** on the TM-D700 transceiver.
- 7 Press **[MHz]** on the TM-D700 transceiver to transfer the frequency data to the TS-480 transceiver.
 - If the transferred frequency data is available on the TS-480 transceiver, the frequency data will be overwritten to the current operating frequency. Otherwise, the operating frequency of the TS-480 transceiver remains unchanged.

For more detailed operation on the DX PacketCluster operation of the TM-D700 transceiver, refer to page 6 of the TM-D700 instruction manual (Specialized Communications).

Note: The firmware of the TM-D700 transceiver must be version G2.0 or later to use the DX PacketCluster Tune function.

CROSSBAND REPEATER

If you have a TM-D700 transceiver, you can connect the TM-D700 transceiver to the TS-480 transceiver to use the Crossband repeater function. Connect the 2 transceivers with a mini DIN cable (6-pin) as shown below.

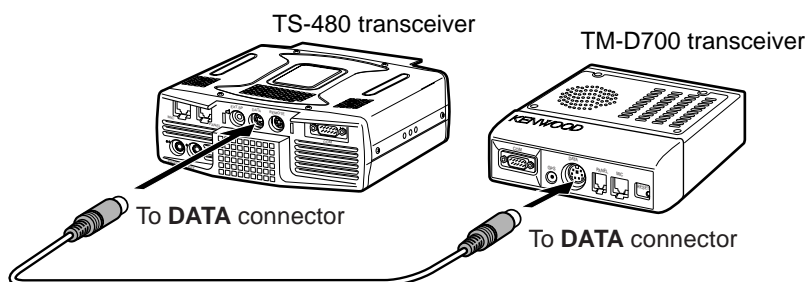

After connecting the 2 transceivers with the cable, access Menu No. 57 (DTS polarity) on the TS-480 transceiver and select “on”. You will further need to adjust the audio input/ output level of the TS-480 transceiver using Menu Nos. 46 and 47.

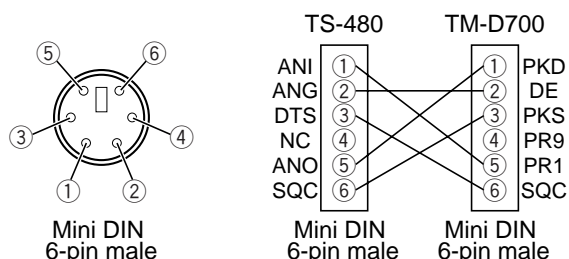

14 CONNECTING PERIPHERAL EQUIPMENT

SKY COMMAND II (K-TYPE ONLY)

■ TM-D700A

In order to connect the TS-480 transceiver to the TM-D700A transceiver, you need to prepare 3 cables by yourself. For the connection between the COM connectors on the 2 transceivers, you may use a commercially available RS-232C cross-wired cable.

Note:

- ◆ Switch OFF both the TM-D700 and TS-480 transceiver before making the connection.
- ◆ The TM-D700A transceiver automatically transmits its call sign in Morse code at regular intervals because of legal requirements; therefore, transmit sidetone must be output from the TS-480 transceiver.
- ◆ When the TM-D700A transceiver is too close to the TS-480 transceiver, unwanted feedback may cause malfunction.
- ◆ Do not share a regulated power supply between the TM-D700A transceiver and the TS-480 transceiver. Unwanted feedback may cause malfunction.

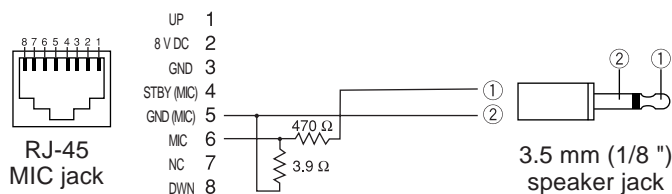
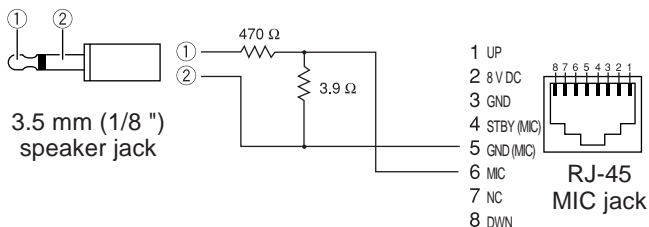
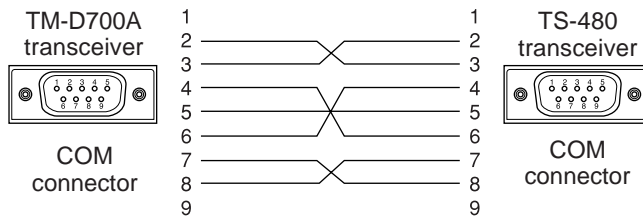

INSTALLING OPTIONS

You will require a #1 Philips screwdriver to install the VGS-1. To install the YF-107 IF filter(s) and/ or SO-3 TCXO, you will also need a soldering iron (approx. 30 watts).

REMOVING THE TOP COVER

When installing the optional VGS-1, YF-107 IF filters or SO-3 TCXO, remove the top cover of the transceiver:

- 1 Remove the 8 screws.

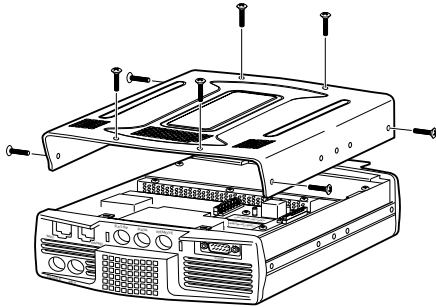

- 2 Lift off the top cover.

VGS-1 VOICE GUIDE & STORAGE UNIT



SWITCH OFF THE POWER AND UNPLUG THE DC POWER CABLE BEFORE BEGINNING INSTALLATION.

- 1 Remove the top case (8 screws) {above}.
- 2 Loosen the 4 screws to remove the shield cover.

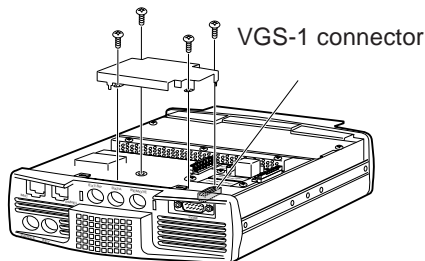

- 3 There are 5 rubber cushions in the VGS-1 package. Use the 2 rubber cushions shown below and attach them to the VGS-1. The remaining cushions are not used.

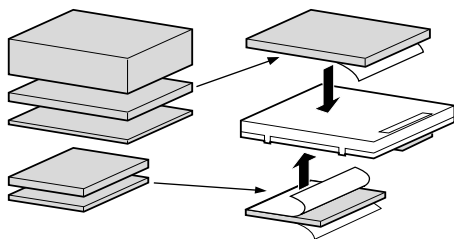

- 4 Plug the VGS-1 into the VGS-1 connector of the PC board, pressing down on the top of the VGS-1 until secure.

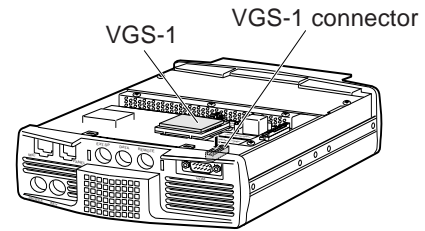

- 5 Replace the shield cover and tighten the 4 screws.
- 6 Replace the top case (8 screws).

Note: After the installation, you can adjust the VGS-1 playback volume by selecting Menu Nos. 14 and 15.

YF-107C/ CN/ SN IF FILTERS AND SO-3 TCXO



SWITCH OFF THE POWER AND UNPLUG THE DC POWER CABLE BEFORE BEGINNING INSTALLATION.

Three different types of IF filters (YF-107C, YF-107CN, and YF-107SN) are available for the TS-480 transceiver. You can install a maximum of 2 IF filters in the transceiver. Refer to page 90 for the bandwidth information on each filter. As for the SO-3 option improves the transceiver frequency stability to ± 0.5 ppm.

- 1 Remove the top case (8 screws).
- 2 Locate the filter and TCXO PCB and loosen the 3 screws.

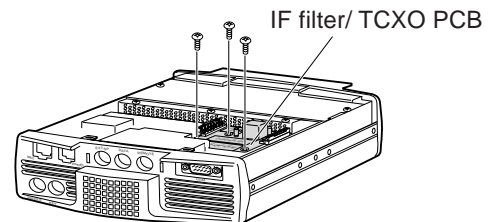

- 3 Unlatch the connectors by pressing the connector tabs upwards.

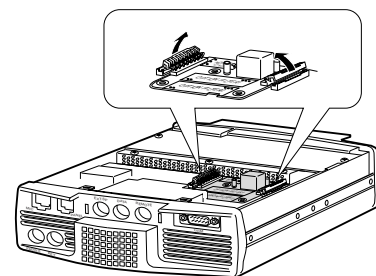

- 4 Insert the IF filter(s) and/ or SO-3 TCXO.

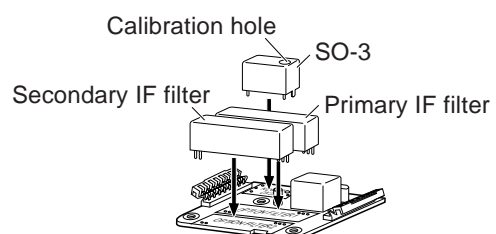

15 INSTALLING OPTIONS

- SO-3: The calibration hole must be on the right side, looking from the front panel.
 - IF filters: Insert a primary IF filter in the OPTION FILTER1 location, and a secondary IF filter in the OPTION FILTER2 location. The transceiver automatically detects what optional IF filter(s) is installed when it is turned ON.
- 5 Solder all pins on the reverse side of the PCB.
- SO-3: Cut the 2 wires marked as R103 and R104, as shown below.

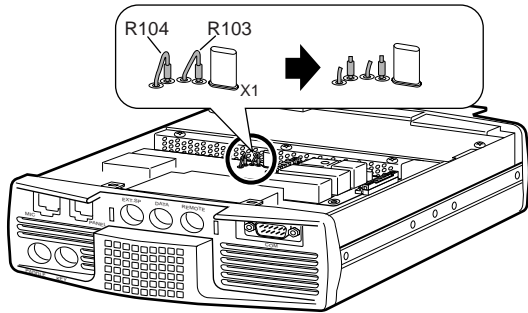

- 6 Replace the PCB in the transceiver and press both the tabs downwards until secure.
- 7 Tighten the 3 screws and replace the top cover.

REFERENCE FREQUENCY CALIBRATION

Note: The transceiver is adjusted at the factory prior to shipping. Unless necessary, DO NOT perform this adjustment.

- 1 Set the following on the transceiver:
 - Mode: CW
 - **AF** control: Center
 - Menu No. 34 (CW RX pitch): 800 Hz
 - **IF SHIFT** control: Center
 - RIT function: OFF
 - Break-in function (VOX): OFF
- 2 Remove the top case (8 screws) from the transceiver.
- 3 Tune in a standard frequency station such as WWV or WWVH at, for example, 10.000.00 or 15.000.00 MHz.
 - Adjust the **Tuning** control so that the display reads the exact frequency of the station.
 - You should hear a beat tone of approximately 800 Hz.
 - For 800 Hz:
$$f_{af} = (f_{display} / 15.600 \times \Delta f_{reference}) + 800 \text{ Hz}$$
where $\Delta f_{reference}$ is the shift from the 15.6 MHz reference frequency.
- 4 Close your CW key. You will hear a transmit sidetone of approximately 800 Hz.
 - This sidetone produces a double beat tone when it combines with the received signal.
 - Adjust the **AF** control to hear the double beat clearly.
 - For 800 Hz:
$$f_{sidetone} = 800 \text{ Hz} \pm 50 \text{ ppm} (= 800 \pm 0.04 \text{ Hz})$$
where $\Delta f_{reference}$ is the shift from the 15.6 MHz reference frequency.

5 TS-480 transceiver without SO-3:

Adjust the trimmer (TC1) to minimize the frequency difference between the received 800 Hz tone and the 800 Hz sidetone.

TS-480 transceiver with SO-3:

Adjust the trimmer inside the SO-3 using the supplied plastic adjustment tool (W01-0406-XX). Minimize the frequency difference between the received 800 Hz tone and the 800 Hz sidetone.

- 6 Replace the top cover (8 screws).

GENERAL INFORMATION

Your transceiver has been factory aligned and tested to specification before shipment. Under normal circumstances, the transceiver will operate in accordance with these operating instructions. All adjustable trimmers, coils and resistors in the transceiver were preset at the factory. They should only be readjusted by a qualified technician who is familiar with this transceiver and has the necessary test equipment. Attempting service or alignment without factory authorization can void the transceiver warranty.

When operated properly, the transceiver will provide years of service and enjoyment without requiring further realignment. The information in this section gives some general service procedures requiring little or no test equipment.

SERVICE

If it is ever necessary to return the equipment to your dealer or service center for repair, pack the transceiver in its original box and packing material. Include a full description of the problems experienced. Include both your telephone number and fax number (if available) along with your name and address in case the service technician needs to call for further explanation while investigating your problem. Don't return accessory items unless you feel they are directly related to the service problem.

You may return your transceiver for service to the authorized **KENWOOD** dealer from whom you purchased it or any authorized **KENWOOD** service center. A copy of the service report will be returned with the transceiver. Please do not send subassemblies or printed circuit boards. Send the complete transceiver.

Tag all returned items with your name and call sign for identification. Please mention the model and serial number of the transceiver in any communication regarding the problem.

SERVICE NOTE

If you desire to correspond on a technical or operational problem, please make your note short, complete, and to the point. Help us help you by providing the following:

- 1 Model and serial number of equipment
- 2 Question or problem you are having
- 3 Other equipment in your station pertaining to the problem
- 4 Meter readings
- 5 Other related information (Menu setup, mode, frequency, key sequence to induce malfunction, etc.)

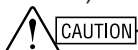

CAUTION

DO NOT PACK THE EQUIPMENT IN CRUSHED NEWSPAPERS FOR SHIPMENT! EXTENSIVE DAMAGE MAY RESULT DURING ROUGH HANDLING OR SHIPPING.

Note:

- ◆ Record the date of purchase, serial number and dealer from whom the transceiver was purchased.
- ◆ For your own information, retain a written record of any maintenance performed on the transceiver.
- ◆ When claiming warranty service, please include a photocopy of the bill of sale, or other proof-of-purchase showing the date of sale.

CLEANING

The keys, controls and case of the transceiver are likely to become soiled after extended use. Remove the controls from the transceiver and clean them with a neutral detergent and warm water. Use a neutral detergent (no strong chemicals) and a damp cloth to clean the case.

BACKUP BATTERY

This transceiver uses an EEPROM (a.k.a. Flash ROM) to store memory channel data, menu configurations and all necessary operation parameters. So, you never have to worry about replacing batteries to operate the transceiver.

16 TROUBLESHOOTING

TROUBLESHOOTING

The problems described in this table are commonly encountered operational malfunctions. These types of difficulties are usually caused by improper hook-up, accidental incorrect control settings, or operator error due to incomplete programming. These problems are usually not caused by circuit failure. Please review this table, and the appropriate section(s) of this instruction manual, before assuming your transceiver is defective.

Note: *Placing a powered portable transceiver near this transceiver may cause noise in the transceiver.*

Problem	Probable Cause	Corrective Action	Page Ref.
The transceiver will not power up after connecting a 13.8 V DC power supply and pressing [ϕ]. Nothing appears on the display, and no receiver noise is heard.	<ol style="list-style-type: none"> 1 DC power supply is OFF. 2 Faulty power cable 3 The power cable is not connected securely. 4 Power cable fuse is open. 	<ol style="list-style-type: none"> 1 Switch ON the DC power supply. 2 Inspect the power cable. Confirm polarities are correct. Red: positive (+); Black: negative (-) 3 Confirm the connections to the DC power supply are secure. 4 Look for the cause of the blown fuse. After inspecting and correcting any problems, install a new fuse of the specified rating. 	<p>18 2, 3</p> <p>2, 3</p> <p>5</p>
After switching ON the power, the transceiver does not function normally. For example, no digits or incorrect digits appear on the display.	<ol style="list-style-type: none"> 1 The input voltage is outside 13.8 V DC $\pm 15\%$ (11.7 to 15.8 V DC). 2 The microprocessor has malfunctioned. 	<ol style="list-style-type: none"> 1 Correct the input voltage or use a 12 to 16 V battery. 2 Review "MICROPROCESSOR RESET". After understanding what data will be lost, do a Partial Reset. If the problem remains, do a Full Reset. 	<p>2, 3</p> <p>88</p>
After switching ON the transceiver, the transceiver refuses to transmit.	<ol style="list-style-type: none"> 1 The current rating of the DC power supply is too low. 2 Two same DC power supplies (20.5 A or more each) or a DC power supply that has 41 A more current capacity. 	<ol style="list-style-type: none"> 1 Use the DC power supply that has 20.5 A or more current rating. 2 Connect 2 DC power supplies to the TS-480HX transceiver. The voltage difference between 2 DC power supplies must be within 1.0 V to transmit. Also, confirm each DC power supply has a 20.5 A or higher current rating. If a DC power supply that has 41 A more current capacity, two same type of DC cables must be used. 	<p>3</p> <p>3</p>
The transceiver does not respond correctly after pressing key combinations or turning controls per instructions in this manual.	<ol style="list-style-type: none"> 1 Procedures are not being followed precisely. 2 The Frequency Lock function is ON. 3 The microprocessor and its memory need resetting. 	<ol style="list-style-type: none"> 1 Review "WRITING CONVENTIONS FOLLOWED". 2 Press [MENU/ F.LOCK] (1 s) to switch the function OFF. 3 Review "MICROPROCESSOR RESET". After understanding what data will be lost, do a Partial Reset. If the problem remains, do a Full Reset. 	<p>ii</p> <p>63</p> <p>88</p>
The frequency cannot be changed.	The Frequency Lock function or Lock All function is ON.	Press [MENU/ F.LOCK] (1 s) to turn the Frequency Lock function OFF. The "F" icon disappears.	63
SSB audio quality is very poor; the high or low audio frequencies are absent.	<ol style="list-style-type: none"> 1 The wrong operation mode is selected for the receiver. 2 The AF DSP filter is incorrectly set. 3 Noise Reduction 1 or 2 is ON. 4 Beat Cancel 1 or 2 is ON. 	<ol style="list-style-type: none"> 1 Select USB or LSB for the mode. 2 Press [FIL/ NAR] then turn the MULTI control to adjust the DSP filter width. 3 Press [NR] until the NR function turns OFF. 4 Press [BC/ CW.T] until the BC function turns OFF. 	<p>19</p> <p>46</p> <p>47</p> <p>47</p>

Problem	Probable Cause	Corrective Action	Page Ref.
No signals are received or receive sensitivity seems poor.	1 The SQL control is fully clockwise.	1 Turn the SQL control counterclockwise.	19
	2 The Attenuator function is ON.	2 Press [ATT/PRE/ ANT1/2] until "ATT" and "PRE" disappear.	61
	3 Mic [PTT] is pressed.	3 Release Mic [PTT] .	20
	4 The IF filter bandwidth was incorrectly set.	4 Review "DSP FILTERS", "CHANGING THE IF FILTER BANDWIDTH" and set the controls accordingly.	45, 46
	5 The wrong antenna connector (ANT 1 or ANT 2) was selected.	5 Press [ATT/PRE/ ANT1/2] (1 s) to select the other antenna connector.	60
	6 The preamplifier is OFF.	6 Press [ATT/PRE/ ANT1/2] to switch the function ON.	49
No signals are received or receive sensitivity seems poor; S-meter is reading full scale.	The RF gain was set too low.	Press [MIC/ 5/ RF.G] (1 s) and turn the MULTI control clockwise to increase the RF gain.	18
Received signals are totally unintelligible.	The wrong modulation mode was selected.	Press [MODE] or [MODE] (1 s) to select the correct modulation mode.	19
Memory Scan will not start scanning.	1 The SQL control was not set correctly.	1 Adjust the SQL control to just eliminate background noise.	19
	2 Less than 2 memory channels were unlocked.	2 Unlock at least 2 memory channels.	54
	3 Less than 2 memory channels were programmed.	3 Store data in at least 2 memory channels.	50
Memory Scan will not scan one of the stored channels; the desired channel is NOT locked out.	With Group Scan selected, the channel you want to scan is in a different group.	Select the Memory Group that contains the memory channel you want to scan.	59
Program Scan will not start scanning.	The start and end frequencies are identical.	Store different start and end frequencies.	53
AT does not finish successfully (TS-480SAT or TS-480HX with AT-300).	The impedance of the coaxial cable and antenna was not matched. Tuning does not successfully finish depending on conditions although the SWR meter indicates smaller than 3:1.	Adjust the antenna system to lower the SWR.	60
The internal tuner is bypassed immediately after tuning is started.	The SWR of the antenna system is too high.	Adjust the antenna system to lower the SWR.	60
You cannot transmit even though you press Mic [PTT] or transmissions result in no contacts.	1 The microphone plug was not inserted completely into the MIC connector.	1 Turn OFF the power, ensure the MIC connector has no foreign objects in it, then plug in the connector firmly.	6
	2 The Transmit Inhibit function is ON.	2 Change Menu No. 55 to OFF.	38
	3 CW or FSK was selected instead of a voice mode.	3 Press [MODE] to select a voice mode.	19
	4 The DSP TX filter bandwidth was improperly selected.	4 Adjust the settings in Menu No. 20.	38
	5 The wrong antenna connector (ANT 1 or ANT 2) was selected.	5 Press [ATT/PRE/ ANT1/2] (1 s) to select the other antenna connector.	60

16 TROUBLESHOOTING

Problem	Probable Cause	Corrective Action	Page Ref.
Attempting to transmit results in the "HELLO" message appearing and the reception mode being restored.	1 The antenna is not connected correctly.	1 Check the antenna connection. Correct as necessary.	2, 4
	2 The impedances of the antenna and transceiver are not properly matched.	2 Reduce the SWR of the antenna system.	2, 4
	3 The input voltage is outside 13.8 V DC \pm 15% (11.7 to 15.8 V DC).	3 Correct the input voltage or use a 12 to 16 V battery.	2
	4 The current rating of the DC power supply is not enough.	4 Use a DC power supply that has a current rating of more than 20.5 A at 13.8 V DC. As for the TS-480HX, 2 DC power supplies are required to transmit.	3
The transceiver has low transmission power.	1 The microphone gain is set too low.	1 When in SSB or AM mode, increase the microphone gain.	27, 28
	2 Poor antenna system connections are causing high SWR.	2 Check the antenna connections. Confirm that the antenna tuner is reporting a low SWR.	60
VOX does not operate.	The VOX gain is set too low.	Increase the VOX gain.	36
HF/ 50 MHz Linear amplifier does not operate.	1 The linear amplifier control is OFF.	1 Set Menu No. 28 (HF) or 29 (50 MHz) to 1, 2, or 3.	63
	2 The REMOTE connector wiring is wrong or faulty.	2 Inspect the REMOTE connector wiring and correct it as necessary.	77
The transceiver's output power decreases after a short operating time.	1 The air filters for the cooling fan(s) have been congested with dust.	1 Contact a KENWOOD authorized service center to clean the filters.	89
	2 The cooling fan(s) cannot provide enough air flow to cool the transceiver down.	2 Relocate the transceiver so that air can easily flow through the TX/ RX unit to keep the unit cooled.	89
You cannot access and use repeaters.	1 Many repeaters require a subtone or 1750 Hz tone to access.	1 Review "FM REPEATER OPERATION" and select the correct frequency and type of subtone.	31
	2 Transmission and/ or reception frequency is wrong.	2 You must transmit on the repeater's input frequency and receive on the repeater's output frequency. Refer to "FM REPEATER OPERATION".	31
Digital operation results in few or no connects or contacts with other stations.	1 Physical connections between the transceiver, computer, and TNC/ MCP is incorrect, or software settings in the TNC/ MCP are wrong.	1 Re-check all connections using this manual, your TNC/ MCP manual, and your computer hardware manual as references.	77, 78
	2 Different transmission and reception frequencies are being used.	2 Confirm that the RIT and XIT functions are switched OFF. Confirm that you are NOT operating split frequency.	35, 37
	3 The levels between the transceiver and the TNC/ MCP are incorrect.	3 Adjust TX and RX levels using Menu No. 46 and 47, and level controls on your TNC/ MCP.	77, 78
	4 Your transmitted signal or the incoming receive signal is too weak.	4 Reorient/ relocate your antenna or increase your antenna gain.	2, 4
	5 The TX delay time parameter in your TNC/ MCP was incorrectly set.	5 Set the TNC/ MCP TX delay time to more than 300 ms.	–
Attempts at controlling the transceiver with the computer have failed.	1 Problem with the cable that connects the PC to the TS-480HX/ SAT.	1 Check the cable and cable connections.	76
	2 Communication parameters set in your terminal program do not match the transceiver parameters.	2 Use the same parameters in the terminal program and the transceiver. Check Menu No. 56.	67

Problem	Probable Cause	Corrective Action	Page Ref.
"TEMP-HI" appears and "CHECK" in Morse code sounds.	A sensor in the transceiver detected high temperature.	Stop transmitting and let the transceiver cool down for a while. Contact a KENWOOD authorized service center to clean the internal air filters.	–
"PA ERROR" and "CHECK" in Morse code sounds, then the transmission stops (TS-480HX only).	A sensor in the transceiver detected malfunctions in the TX power amplifier circuit.	Let the transceiver cool down for a while, then perform the Full reset. If the problem persists, contact a KENWOOD authorized service center for repairs.	88
"RX ONLY" appears and "CHECK" in Morse code sounds (TS-480HX only).	1 The DC cable is not connected to the DC-2 connector.	1 Apply (or connect) the DC power source to the DC-2 connector.	2, 3
	2 The voltage difference between the DC-1 and DC-2 connectors on the transceiver is greater than 1.0 V DC.	2 Confirm that the output DC voltage of both DC power supplies is 13.8 V DC. The difference must be within 1.0 V DC.	2, 3
"DC ERROR" appears and "CHECK" in Morse code sounds.	The voltage of the DC power supply(s) is too high.	Adjust the DC power supply voltage to 13.8 V DC.	3
Transmission suddenly stops.	1 The voltage difference between DC-1 and DC-2 connectors on the transceiver becomes greater than 1.0 V DC.	1 Confirm that the output DC voltage of both DC power supplies is 13.8 V DC. The difference must be within 1.0 V DC.	2, 3
	2 The voltage of the DC power supply(s) is too high.	2 Adjust the DC power supply voltage to 13.8 V DC.	3
	3 Two different type of DC cables are used.	3 Use same type of DC cables.	2, 3
"VGS ERR" appears.	An internal error occurred in the VGS-1.	Confirm the connector of VGS-1 is securely connected to the transceiver. Perform the Full reset. If the problem persists, contact a KENWOOD authorized service center for repairs.	83, 88
A message cannot be recorded/ played back or no announcement can be heard.	There is a communication error between the transceiver and VGS-1.	Confirm the connector of VGS-1 is securely connected to the transceiver. Perform the Full reset. If the problem persists, contact a KENWOOD authorized service center for repairs.	83, 88
The transceiver output power seems to be low in SSB mode.	Most of the external RF power meters measure the average RF power. So, the meter reading is low when you operate and talk in SSB mode. The LCD meter used in the TS-480 has relatively fast response time but it is not fast enough to measure the accurate PEP (peak envelope power).	Apply a continuous single tone (1 kHz) to the microphone audio input to measure the RF output power. The PEP will be the same as this RF output level.	–

MICROPROCESSOR RESET

If your transceiver seems to be malfunctioning, resetting the microprocessor default settings may resolve the problem. There are 2 levels of resetting the microprocessor of the TS-480 transceiver: Partial Reset and Full Reset.

INITIAL SETTINGS

For each VFO, the factory defaults for the operating frequency and mode are as follows:

- VFO A: 14.000.00 MHz/ USB
- VFO B: 14.000.00 MHz/ USB

The Memory channels and Quick Memory channels have no data stored.

PARTIAL RESET

Perform a Partial Reset if a key or control does not function according to the instructions in this manual. The following data is NOT erased by performing a Partial Reset.

- Memory channel data
- Menu settings
- Antenna tuner preset data
- ANT 1/ ANT 2 selection data
- Frequency and mode data for the Auto Mode function
- Various adjustment setting values

Reset the transceiver by pressing **[A/B / M/V]+[⏻]**.

- A confirmation message appears when performing the Partial Reset. Press **[A/B / M/V]** to proceed. Otherwise, press any other key to cancel the Partial Reset and return to normal operation.
- The VFOs reset to the factory default values.

FULL RESET

Perform a Full Reset if you want to erase all the data in all the memory channels. In addition, this function resets all the settings that you customized, to the factory defaults (i.e.- menu settings, antenna tuner preset data, etc.).

Reset the transceiver by pressing **[A=B/ SPLIT]+[⏻]**.

A confirmation message appears when performing Full Reset. Press **[A=B/ SPLIT]** to proceed. Otherwise, press any other key to cancel the Full Reset and return to normal operation.

When you perform the Full Reset:

- All frequencies, modes, memory data, adjustment values, and AT preset data are set to the factory default values.

DEMONSTRATION MODE

The transceiver can be configured to enter the demonstration mode for display purposes. To enter the demonstration mode:

- 1 Switch the transceiver OFF.
- 2 Press **[MENU/ F.LOCK]+[⏻]** to switch the transceiver ON.
 - The display brightness changes, the LED turns ON/ OFF, and alpha-numeric segments turn ON/ OFF automatically.
 - If you operate the transceiver while in the demonstration mode, the demonstration is temporarily paused. But, if no operation is performed for more than 10 seconds, the demonstration starts again.
- 3 To exit the demonstration mode, first turn the transceiver OFF, then press **[MENU/ F.LOCK]+[⏻]** to turn the transceiver ON.

Note: You cannot exit the demonstration mode by simply switching the transceiver OFF. You must switch the transceiver OFF then press **[MENU/ F.LOCK]+[⏻]** to turn the transceiver ON in order to exit the demonstration mode.

OPERATION NOTICES

The transceiver has been designed and engineered to avoid possible hardware glitches. However, you may notice the following symptoms when you operate the transceiver. These symptoms are not malfunctions.

DC POWER SUPPLY

As stated in the SPECIFICATIONS {page 91}, this transceiver requires a supplied DC voltage source of 13.8 V \pm 15%. If you find that the transceiver cannot be switched ON, or that it shuts OFF automatically, the DC voltage may be outside the specified range.

In such a case, remove the DC cable from the transceiver immediately and confirm that the supplied voltage is within the specified range.

FAN NOISES

When the TX/ RX unit is installed in a non-ventilated area, the cooling fan(s) may increase in speed and emit a high level of noise for a long time. This is because the TX/ RX unit cannot be cooled down with the regular fan speed. In this case, relocate the TX/ RX unit so that air can easily flow through the TX/ RX unit to keep the unit cooled.

INTERNAL BEATS

On some spots of the receiver frequencies, the S-meter moves or you cannot receive any signals. This is inevitable when you use superheterodyne receivers. You may notice the signals on the following spots of the frequency.

15.600.00 MHz, 31.200.00 MHz, 46.800.00 MHz

AGC

When you turn the AGC function OFF {page 35}, the receiving audio signals can be distorted. In this case, decrease the RF gain, turn the pre-amplifier OFF, or turn the attenuator ON. In general, the RF gain must be greatly reduced when the AGC is turned OFF.

60 m BAND OPERATION (K-TYPE/ U. S. A. ONLY)

Effective from July 3, 2003, FCC Report and Order (R&O) in ET Docket 02-98 granted US amateurs secondary access to five discrete channels in the vicinity of 5 MHz. General, Advanced, and Amateur Extra licensees may use the following five channels on a secondary basis with a maximum effective radiated power of 50 W PEP relative to a half wave dipole. Only upper sideband suppressed carrier voice transmissions may be used. The frequencies are 5330.5, 5346.5, 5366.5, 5371.5 and 5403.5 kHz. The occupied bandwidth is limited to 2.8 kHz centered on 5332, 5348, 5368, 5373, and 5405 kHz respectively. The TS-480 transceiver stops at this new 60 m band as you scroll up or down amateur radio frequency bands. For more information, contact ARRL or search their Web site (<http://www.arrl.org>) with a key word, "60 meter".

OPTIONAL ACCESSORIES

ARCP-480/ ARHP-10
Remote control software



Refer to page 68 for details.

HS-5
Delux Headphones



HS-6
Small Headphones



LF-30A
Low-pass Filter



TS-480SAT only

MC-43S
Microphone



MJ-88 is required.

MC-47
Multi-function Microphone



MJ-88 is required.

MC-60A
Desk-top Microphone



MJ-88 is required.

MJ-88
Plug adaptor
(8-pin metal to RJ45)



PG-20
DC cable (7 m/ 23 ft)



PG-4Z
Extension cable kit
(4 m/ 13 ft)



PS-53
Regulated DC Power
Supply (22.5 A)



SO-3
TCXO unit



SP-50B
Mobile Speaker



SP-23
External Speaker



VGS-1
Voice Guide and Storage
unit

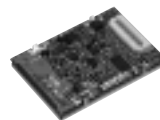

YF-107CN
270 Hz IF filter



YF-107C
500 Hz IF filter



YF-107SN
1.8 kHz IF filter



SPECIFICATIONS

General		TS-480SAT	TS-480HX
Mode		J3E (LSB, USB)/ A1A (CW)/ A3E (AM)/ F3E (FM)/ F1B (FSK)	
Number of memory channels		100 + 10 (Quick memory channels)	
Antenna impedance	160 m ~ 6 m band	50 Ω (with built-in antenna tuner 16.7 ~ 150 Ω)	50 Ω
Supply Voltage		DC 13.8 V ±15%	
Grounding method		Negative ground	
Current	Transmit (max.)	20.5 A or less	41.0 A or less
	Receive (no signal)	1.5 A or less	
Usable temperature range		-20°C ~ 60°C (-4°F ~ 140°F)	
Frequency stability without SO-3	-10°C ~ 50°C	Within ±5 ppm	
	-20°C ~ 60°C	Within ±10 ppm	
Frequency stability with SO-3	-10°C ~ 50°C	Within ±0.5 ppm	
	-20°C ~ 60°C	Within ±1.0 ppm	
Dimensions (W x H x D Projections included)	TX/ RX unit	179 x 69.5 x 278 mm/ 7" x 2 3/4" x 10 15/16"	
	Remote Control panel	183 x 78 x 68 mm/ 7 3/16" x 3" x 2 5/8"	
Weight	TX/ RX unit	Approx. 3.2 kg/ 7 lbs	
	Remote Control panel	Approx. 0.5 kg/ 1 lb 2 oz	

Transmitter			TS-480SAT	TS-480HX
Frequency range	160 m band		1.8 ~ 2.0 MHz (K-type)	1.81 ~ 2.0 MHz (E-type)
	80 m band		3.5 ~ 4.0 MHz (K-type)	3.5 ~ 3.8 MHz (E-type)
	60 m band		5.25 ~ 5.45 MHz (K-type)	
	40 m band		7.0 ~ 7.3 MHz (K-type)	7.0 ~ 7.1 MHz (E-type)
	30 m band		10.1 ~ 10.15 MHz	
	20 m band		14.0 ~ 14.35 MHz	
	17 m band		18.068 ~ 18.168 MHz	
	15 m band		21.0 ~ 21.45 MHz	
	12 m band		24.89 ~ 24.99 MHz	
	10 m band		28.0 ~ 29.7 MHz	
Output power	SSB/ CW/ FSK/ FM	Max.	100 W (160 m ~ 6 m band)	200 W (160 m ~ 6 m band)
		Min.	5 W (160 m ~ 6 m band)	5 W (160 m ~ 6 m band)
	AM	Max.	25 W (160 m ~ 6 m band)	50 W (160 m ~ 6 m band)
		Min.	5 W (160 m ~ 6 m band)	5 W (160 m ~ 6 m band)
Modulation	SSB		Balanced	
	FM		Reactance	
	AM		Low level	

20 SPECIFICATIONS

Transmitter		TS-480SAT	TS-480HX
Spurious emissions	160 m ~ 10 m band	-50 dB or less	
	6 m band	-60 dB or less	
Carrier suppression (SSB)		40 dB or more	
Unwanted sideband suppression (modulation frequency 1.0 kHz)		40 dB or more	
Maximum frequency deviation (FM)	Wide	±5 kHz or less	
	Narrow	±2.5 kHz or less	
XIT shift frequency range		±9.99 kHz	
Microphone impedance		600 Ω	

Receiver		TS-480SAT	TS-480HX
Circuit type		SSB/ CW/ AM/ FSK: Double conv. superheterodyne FM: Triple conversion superheterodyne	
Frequency range		0.03 ~ 59.999.999 MHz	
Intermediate Frequency (IF)		1st IF: 73.095 MHz 2nd IF: 10.695 MHz 3rd IF (FM only): 455 kHz	
Sensitivity	SSB/ CW/ FSK (S/N 10 dB)	0.5 ~ 1.705 MHz: 4 μV or less 1.705 ~ 24.5 MHz: 0.2 μV or less 24.5 ~ 30.0 MHz: 0.13 μV or less 50.0 ~ 54.0 MHz: 0.13 μV or less	
	AM (S/N 10 dB)	0.5 ~ 1.705 MHz: 31.6 μV or less 1.705 ~ 24.5 MHz: 2.0 μV or less 24.5 ~ 30.0 MHz: 1.3 μV or less 50.0 ~ 54.0 MHz: 1.3 μV or less	
	FM (12 dB SINAD)	28.0 ~ 30.0 MHz: 0.22 μV or less 50.0 ~ 54.0 MHz: 0.22 μV or less	
Selectivity	SSB	-6 dB: 2.4 kHz or more, -60 dB: 4.4 kHz or less	
	AM	-6 dB: 5.0 kHz or more, -60 dB: 40.0 kHz or less	
	FM	-6 dB: 12.0 kHz or more, -50 dB: 25.0 kHz or less	
Image rejection		70 dB or more	
1st IF rejection		70 dB or more	
Beat Cancel attenuation (at 1 kHz)		40 dB or more	
RIT shift frequency range		±9.99 kHz	
Squelch sensitivity	SSB/ CW/ FSK/ AM	0.5 ~ 1.705 MHz: 18.0 μV or less 1.8 ~ 30.0 MHz: 1.8 μV or less 50.0 ~ 54.0 MHz: 1.1 μV or less	
	FM	28.0 ~ 30.0 MHz: 0.2 μV or less 50.0 ~ 54.0 MHz: 0.2 μV or less	
Audio output (8 Ω, 10% distortion)		2.0 W or more	
Audio output impedance (EXT.SP)		8 Ω	

AF Gain	18	DSP		REMOTE connector	77
AGC	35, 89	Beat Cancel	47	Lock Function	63
AM		Changing the Filter Bandwidth	45	Frequency	63
Narrow Bandwidth for	28	45	Tuning control	63
Transmission	28	DSP Filters	46	Lockout, Memory Channel	54
Amplifier, HF/ 50 MHz Linear Amp.		Beat Cancel 1	47	LSB (see SSB)	
REMOTE connector	77	Beat Cancel 2	47	MCP and TNC	78
AMTOR	43	NR1	47	Memory	
Antenna		NR2	47	Channel Name	54
ANT 1/ ANT 2	60	RX Monitor	48	Conventional	50
Connection	2, 4	Electric Keyer	39	Erasing, Channels	54
Antenna Tuner	60	Auto Weighting	39	Group	59
Anti-VOX Adjustment	36	Bug Key Function	40	Lockout, Channel	54
Attenuator	49, 61	Changing Keying Speed	39	Quick, Recalling Channels	55
Automatic Antenna Tuner	60, 78	Messages, Checking	40	Quick, Storing into	55
Presetting	61	Messages, Storing	40	Quick, Transfers to VFO	55
External Antenna Tuner Type		Messages, Transmitting	40	Recall	51
.....	61	Reverse Keying Weight Ratio		Recall and Scroll	51
Automatic Gain Control	35	39	Resetting	88
Auto CW TX in SSB Mode	41	Swap Dot and Dash Paddle		Scanning, All-Channel	58
Auto Mode	61	Position	41	Scroll	52
Auto Zero-Beat	29	External Antenna Tuner	60, 78	Start/ End Frequencies	53
A=B	35	External Speakers	6, 90	Storing Data in	50
Backup Battery	83	FAX/ Facsimile	44	Temporary Frequency Changes	
Band, Selecting a	19	Fine Tuning	35	52, 55
Beat Cancel	47	FM		Transfer, To Memory	52
Beep Function	62	CTCSS Operation	33	Transfer, To VFOs	52
Break-in, Full/ Semi	39	Narrow Bandwidth for	28	Memory Scan	58
Bug Key Function	40	Repeater Operation	31	Menu	22
Carrier-Operated Mode	58	Tone Function	32	Access	22
Cleaning	83	Transmission	27	Alphabetical Function List	26
Clover	43	TX Deviation	28	Configuration	23
COM Connector	15	Frequency		What is a	22
Computer	76	Correction for CW	41	Meter	20
Computer Control		Direct, Entry	34	MHz Key, Using	34
Connector (COM)	15, 76	Fine Tuning	35	Microphone	
Setting up	67	Lock	63	Connector (MIC)	15
Crossband Repeater	71, 79	Rounding		Gain	21
CTCSS		Selecting your	34	PF Keys	64
Freq. ID Scan	33	Step Size	34	Mode, Selecting a	19
CW		FSK	(see RTTY)	Monitor, RX	64
Auto TX in SSB Mode	41	Full Break-in	39	Noise Blanker	47
Break-in, Full	39	Full Reset	88	Noise Reduction	47
Break-in, Semi	39	Fuses, Replacing	5	Normal Scan	56
Frequency Correction for	41	Gain		Optional Accessories	90
Key jack	7	AF	18	Installation	81
Message Memory	40	RF	18	PacketCluster Tune	72, 79
Pitch	29	G-TOR	43	Packet Radio	43, 48
Reverse (Reception)	49	Headphones (PHONES)	7	PacTOR	43
Reverse Keying Weight Ratio		IF Filter		Partial Reset	88
.....	39	Bandwidth Change	45	PF Key	64
Sidetone, TX	29	Shift	45	Pitch, Frequency	29
Sidetone, Volume	29	Internal Beats	89	Power	
Transmission	29	Key Jack (PADDLE/ KEY)	7	Connecting DC	
Zero Beat, Auto	29	Keyer, Electronic		Supply Connection	3
Data Communication DSP Filter		Auto Weighting	39	Switching ON/OFF	18
.....	48	Bug Key Function	40	TX	65
DATA Connector	15, 78	Changing Keying Speed	39	Voltage	89
Demonstration Mode	88	Insert Keying	41	Pre-amplifier	49
Direct Frequency Entry	34	Messages, Checking	40	Program Scan	56
Display		Messages, Storing	40	Partially Slowed	57
Brightness	63	Messages, Transmitting	40	Programmable	
Key Illumination	63	Reverse Keying Weight Ratio .	39	Key	(See PF Key)
LCD	13, 14	Key Illumination	63	VFO	54
DNL (Digital Noise Limiter)	47	LCD	(See Display)	PSK31	43, 48
		Lightening Protection	4	Quick Data Transfer	
		Linear Amplifier		Compatible Equipment	79
		Control	63		

19 INDEX

Connections	79	USB	(see SSB)
Equipment, Needed	66, 79	VFO	
Using	66	Equalizing (A=B)	35
Quick Menu		Programmable	54
Programming the	22	Scan	56
Using the	22	Selecting A or B	18
Quick QSY	34	VGS-1 Voice Guide and Storage	
Radio Teletypewriting (See RTTY)		Unit (optional)	68, 81
Reference Frequency Calibration		Announcement Speed	71
.....	82	Announcement Volume	71
Repeater Operation	31	Checking Messages	69
Reset		Constant Recording	69
Full	88	Erasing a Recorded	
Partial	88	Message	69
RF Gain	18	Installation	81
RIT	35	Interval Time, Changing	69
RTTY		Message Playback	69
Operation	77	Message Playback Volume	69
Tone	42	Recording Messages	68
RX DSP Equalizer	64	Sending Messages	69
RX Monitor	64	VOICE1	70
RX Pitch Frequency	29	VOICE2	70
Scan		Voice Guide	70
All-Channel	58	Volume	
Carrier-Operated mode	58	AF Gain	18
Group	59	RF Gain	18
Group Select	59	VOX (Voice-Operated Transmit)	
Hold	57	Delay Time	36
Memory, Group	59	Microphone Input Level	36
Program	56	XIT	37
Resume Method	58	Zero-Beat, Auto	29
Time-Operated mode	58		
Semi Break-in	39	60 m Band Operation	89
Sidetone			
Changing, the Volume	29		
Pitch	(See Pitch, Frequency)		
Sky Command II	73, 80		
Slow Scan TV	(See SSTV)		
SO-3	81		
Specifications	91		
Speech Processor	37		
Split-Frequency Operation	30		
Squelch, Adjusting	19		
SSB, Transmission	27		
SSTV	44		
TF-SET	30		
Time-Operated Mode	58		
Time-out Timer	65		
Tone			
Activating the Function	32		
Frequency ID Scan	32		
Selecting a, Frequency	32		
Transmitting a	32		
1750 Hz	32		
Tuning control Adjustment Rate			
.....	35		
Transmit Inhibit	38		
Transmission	20, 27-29, 36		
Transverter	65		
Troubleshooting	84		
TX Equalizer	38		
TX Filter Bandwidth	38		
TX Monitor	65		
TX Power	20, 65		
TX/ RX Unit	15, 16		
TX Tune	66		

KENWOOD

CE 0682 